



US007028034B2

(12) **United States Patent**
Wesinger, Jr. et al.

(10) **Patent No.:** **US 7,028,034 B2**
(45) **Date of Patent:** ***Apr. 11, 2006**

(54) **METHOD AND APPARATUS FOR PROVIDING A DYNAMICALLY-UPDATING PAY-FOR-SERVICE WEB SITE**

(56) **References Cited**

(75) Inventors: **Ralph E. Wesinger, Jr.**, San Jose, CA (US); **Christopher D. Coley**, Morgan Hill, CA (US)
(73) Assignee: **GraphOn NES Sub, LLC**, Santa Cruz, CA (US)
(*) Notice: Subject to any disclaimer, the term of this patent is extended or adjusted under 35 U.S.C. 154(b) by 0 days.

This patent is subject to a terminal disclaimer.

U.S. PATENT DOCUMENTS

3,581,072 A	5/1971	Nymeyer	235/152
3,956,615 A	5/1976	Anderson et al.	235/61.7
4,754,428 A	6/1988	Schultz et al.	364/900
4,799,156 A	1/1989	Shavit et al.	364/401
4,805,099 A	2/1989	Huber	364/300
4,805,134 A	2/1989	Calo et al.	364/900
4,962,475 A	10/1990	Hernandez et al.	364/900
4,989,141 A	1/1991	Lyons et al.	364/408
4,992,940 A	2/1991	Dworkin	364/401
5,063,507 A	11/1991	Lindsey et al.	364/408
5,107,443 A	4/1992	Smith et al.	395/158
5,136,501 A	8/1992	Silverman et al.	364/408
5,164,897 A	11/1992	Clark et al.	364/401
5,168,446 A	12/1992	Wiseman	364/408

(21) Appl. No.: **10/844,599**

(Continued)

(22) Filed: **May 11, 2004**

OTHER PUBLICATIONS

(65) **Prior Publication Data**

Akkiraju, Praveen et al., White Paper, Enabling Enterprise Multihoming with Cisco IOS Network Address Translation (NAT), 25 pages, 1997 (no month).

US 2005/0125373 A1 Jun. 9, 2005

Related U.S. Application Data

(Continued)

(63) Continuation of application No. 10/703,823, filed on Nov. 7, 2003, which is a continuation of application No. 09/952,985, filed on Sep. 14, 2001, now Pat. No. 6,850,940, which is a continuation of application No. 09/110,708, filed on Jul. 7, 1998, now Pat. No. 6,324,538, which is a continuation of application No. 08/572,543, filed on Dec. 14, 1995, now Pat. No. 5,778,367.

Primary Examiner—Frantz Coby

(74) *Attorney, Agent, or Firm*—Sierra Patent Group, Ltd.

(51) **Int. Cl.**
G06F 17/30 (2006.01)

(52) **U.S. Cl.** **707/10; 707/100; 707/102; 705/1; 705/26**

(57) **ABSTRACT**

(58) **Field of Classification Search** **707/10, 707/100, 102; 705/1, 26; 709/215, 216, 709/217**

A web server for providing a dynamically-updating pay-for-service web site is disclosed. The web server includes an HTML front-end entry process configured to create and store personal homepage content in a database for a owner, receive a fee for making the personal homepage accessible on a network. The HTML front-end update process is also configured to allow the owner to update their personal homepage over a network.

See application file for complete search history.

22 Claims, 25 Drawing Sheets

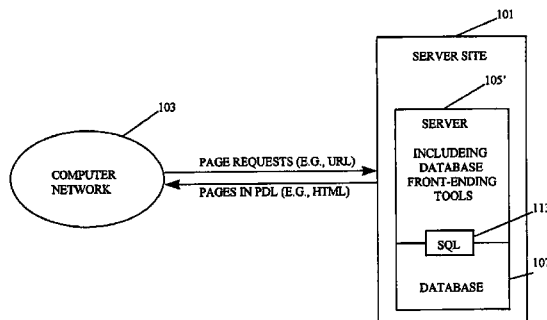
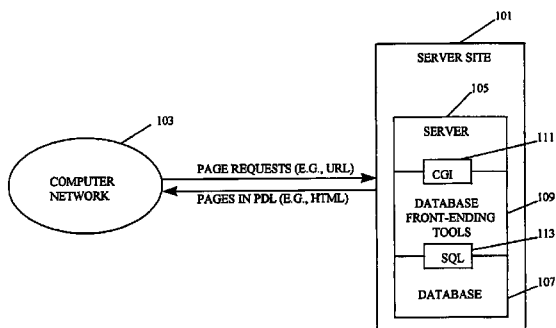

U.S. PATENT DOCUMENTS

5,189,608 A	2/1993	Lyons et al.	364/408	5,699,526 A	12/1997	Siefert	395/227
5,197,004 A	3/1993	Sobotka et al.	364/419	5,706,507 A	1/1998	Schloss	395/615
5,197,005 A	3/1993	Schwartz et al.	364/419	5,708,780 A	1/1998	Levergood et al.	395/200.12
5,204,947 A	4/1993	Bernstein et al.	395/157	5,710,887 A	1/1998	Chelliah et al.	395/226
5,235,680 A	8/1993	Bijnagte	395/161	5,710,918 A	1/1998	Lagarde et al.	395/610
5,243,515 A	9/1993	Lee	364/401	5,715,314 A	2/1998	Payne et al.	380/24
5,257,366 A	10/1993	Adair et al.	395/600	5,715,402 A	2/1998	Popolo	395/237
5,261,102 A	11/1993	Hoffman	395/700	5,717,923 A	2/1998	Dedrick	395/613
5,262,943 A	11/1993	Thibado et al.	364/413.01	5,721,827 A	2/1998	Logan et al.	395/200.47
5,263,157 A	11/1993	Janis	395/600	5,721,906 A	2/1998	Siefert	395/609
5,263,158 A	11/1993	Janis	395/600	5,721,908 A	2/1998	Lagarde et al.	395/610
5,283,731 A	2/1994	Lalonde et al.	364/401	5,724,424 A	3/1998	Gifford	380/24
5,297,249 A	3/1994	Bernstein et al.	395/156	5,727,156 A	3/1998	Herr-Hoyman et al.	395/200.49
5,299,123 A	3/1994	Wang et al.	364/419	5,729,682 A	3/1998	Marquis et al.	395/200.12
5,301,105 A	4/1994	Cummings, Jr.	364/401	5,732,219 A	3/1998	Blumer et al.	395/200.57
5,309,437 A	5/1994	Perlman et al.	370/85.13	5,734,718 A	3/1998	Prafullchandra	380/4
5,319,542 A	6/1994	King, Jr. et al.	364/401	5,734,823 A	3/1998	Saigh et al.	395/200.06
5,325,297 A	6/1994	Bird et al.	364/419.07	5,737,395 A	4/1998	Iribarren	379/88
5,335,346 A	8/1994	Fabbio	395/600	5,737,592 A	4/1998	Nguyen et al.	395/604
5,347,632 A	9/1994	Filepp et al.	395/200	5,742,769 A	4/1998	Lee et al.	395/200.36
5,355,474 A	10/1994	Thuraisingham et al.	395/600	5,742,845 A	4/1998	Wagner	395/831
5,367,619 A	11/1994	Dipaolo et al.	395/149	5,745,556 A	4/1998	Ronen	379/127
5,367,621 A	11/1994	Cohen et al.	395/154	5,748,188 A	5/1998	Hu et al.	345/326
5,386,525 A	1/1995	Noack	395/400	5,748,740 A	5/1998	Curry et al.	380/25
5,394,471 A	2/1995	Ganesan et al.	380/23	5,748,783 A	5/1998	Rhoads	382/232
5,408,655 A	4/1995	Oren et al.	395/600	5,754,939 A	5/1998	Herz et al.	455/4.2
5,410,693 A	4/1995	Yu et al.	395/600	5,754,981 A	5/1998	Veeneman et al.	705/26
5,412,774 A	5/1995	Agrawal et al.	395/157	5,757,917 A	5/1998	Rose et al.	380/25
5,416,694 A	5/1995	Parrish et al.	364/401	5,758,324 A	5/1998	Hartman et al.	705/1
5,418,942 A	5/1995	Krawchuk et al.	395/600	5,761,649 A	6/1998	Hill	705/27
5,426,780 A	6/1995	Gerull et al.	395/600	5,761,656 A	6/1998	Ben Shachar	707/4
5,448,724 A	9/1995	Hayashi	395/182.02	5,761,661 A	6/1998	Coussens et al.	707/9
5,455,945 A	10/1995	VanderDrift	395/600	5,761,662 A	6/1998	Dasan	707/10
5,459,863 A	10/1995	Taylor	395/600	5,761,663 A	6/1998	Bookman et al.	707/104
5,471,617 A	11/1995	Farrand et al.	395/700	5,778,367 A *	7/1998	Wesinger et al.	707/10
5,483,586 A	1/1996	Sussman	379/201	5,784,608 A	7/1998	Meske, Jr. et al.	395/602
5,495,412 A	2/1996	Thiessen	364/401	5,790,793 A	8/1998	Higley	395/200.48
5,502,637 A	3/1996	Beaulieu et al.	364/408	5,802,299 A	9/1998	Logan et al.	395/200.48
5,506,984 A	4/1996	Miller	395/600	5,802,497 A	9/1998	Manasse	705/27
5,513,126 A	4/1996	Harkins et al.	364/514 A	5,812,776 A	9/1998	Gifford	395/200.47
5,530,852 A	6/1996	Meske, Jr. et al.	395/600	5,813,006 A	9/1998	Polnerow et al.	707/10
5,537,546 A	7/1996	Sauter	395/200.01	5,819,285 A	10/1998	Damico et al.	707/104
5,537,590 A	7/1996	Amado	395/600	5,822,745 A	10/1998	Hekmatpour	706/59
5,542,024 A	7/1996	Balint et al.	395/161	5,826,241 A	10/1998	Stein et al.	705/26
5,544,255 A	8/1996	Smithies et al.	382/119	5,832,497 A	11/1998	Taylor	707/104
5,544,360 A	8/1996	Lewak et al.	395/600	5,835,712 A	11/1998	DuFresne	395/200.33
5,553,239 A	9/1996	Heath et al.	395/187.01	5,835,896 A	11/1998	Fisher et al.	705/37
5,557,518 A	9/1996	Rosen	364/408	5,842,173 A	11/1998	Strum et al.	705/1
5,559,958 A	9/1996	Farrand et al.	395/183.03	5,850,446 A	12/1998	Berger et al.	380/24
5,564,119 A	10/1996	Krawchuk et al.	395/600	5,870,552 A	2/1999	Dozier et al.	395/200.49
5,572,643 A	11/1996	Judson	395/793	5,878,141 A	3/1999	Daly et al.	380/25
5,592,375 A	1/1997	Salmon et al.	395/207	5,884,309 A	3/1999	Vanechanos, Jr.	707/10
5,608,903 A	3/1997	Prasad et al.	395/610	5,890,170 A	3/1999	Sidana	707/501
5,623,601 A	4/1997	Vu	395/187.01	6,026,433 A	2/2000	D Arlach et al.	709/217
5,623,652 A	4/1997	Vora et al.	395/610	6,085,219 A	7/2000	Moriya	709/200
5,625,781 A	4/1997	Cline et al.	395/335	6,161,124 A	12/2000	Takagawa et al.	709/203
5,630,125 A	5/1997	Zellweger	395/614	6,317,757 B1	11/2001	Sakamaki	707/502
5,633,910 A	5/1997	Cohen	379/38	6,324,538 B1 *	11/2001	Wesinger et al.	707/10
5,638,457 A	6/1997	Deaton et al.	382/100	6,486,895 B1	11/2002	Robertson et al.	345/776
5,649,192 A	7/1997	Stucky	395/614	6,850,940 B1 *	2/2005	Wesinger et al.	707/10
5,655,077 A	8/1997	Jones et al.	395/187.01				
5,659,741 A	8/1997	Eberhardt	395/615				
5,659,742 A	8/1997	Beattie et al.	395/615				
5,664,115 A	9/1997	Fraser	705/37				
5,664,207 A	9/1997	Crumpler et al.	395/766				
5,675,507 A	10/1997	Bobo, II	364/514 R				
5,677,953 A	10/1997	Dolphin	380/4				
5,678,041 A	10/1997	Baker et al.	395/609				
5,682,525 A	10/1997	Bouve et al.	395/615				
5,684,951 A	11/1997	Goldman et al.	395/188.01				
5,694,546 A	12/1997	Reisman	395/200.9				

OTHER PUBLICATIONS

Andrews, Keith et al., "Serving Information to the Web with Hyper-G", The Third International World-Wide Web Conference, (www'95), Darmstadt, Germany, 6 pages, Apr. 12, 1995.

Anick, Peter G. et al., "A Direct Manipulation Interface for Boolean Information Retrieval via Natural Language Query", *Proceedings of the 13th International Conference*

- On Research and Development in Information Retrieval*, Brussels, Belgium, pp. 135-151, Sep. 5-7, 1990.
- Anonymous, "Amaya New Features History," W3C Amaya, [Internet] http://www.w3.org/Amaya_New_User.html 10 pages, printed Jul. 14, 1998.
- Anonymous, "Amaya—W3C's Browser/Editor" from Amaya Overview, W3C User Interface Domain, [Internet] www.w3.org, 4 pages, printed Jul. 14, 1998.
- Anonymous, "Application Development with Database Repositories", [Internet] [wji.com/wji/b3468.html](http://www.w3.org/wji.com/wji/b3468.html), 10 pages, printed Jul. 22, 1999.
- Anonymous, *Developing Applications with OpenDiS Access Service*, Metaphor Data Interpretation System publication Version 2.0, First Edition, pp. Table of Contents—Index (IX04), Sep. 1994.
- Anonymous, "The Fruitful, Tangled Trees of Knowledge", *The Economist*, Science and Technology Section, pp. 85-88, Jun. 20th -26th, 1992.
- Anonymous, "MORE Technology Transfer", [Internet] rbse.jsc.nasa.gov/eichmann/MORE_sites.html, 7 pages, Jan. 9, 1996.
- Anonymous, "The Oracle World Wide Web Interface Kit", www.inf.ufrgs.br/tools/oraweb etc., 51 pages, no date, printed Jul. 14, 1999.
- Anonymous, "Sybase SQL Server 1: Performance Optimized for Real-World Results", Sybase,® Inc., 10 pages, 1995 (no month).
- Anonymous, (Online Directory and Windows NT Based *Web Development Services*), World Yellow Pages Network ([wyp.net](http://www.wyp.net)) Yellow White Pages, [Internet], [wyp.net](http://www.wyp.net), 7 pages, 1995 (no month), printed Jul. 9, 1996.
- Anonymous, "CGI: Common Gateway Interface", W3C®, [Internet] www.w3.org/CGI, 2 pages, Oct. 13, 1999.
- Anonymous, "CGI: The Common Gateway Interface", [Internet] o.nca.uiuc.edu/cgi/overview.html, 1 page, no date, printed Feb. 21, 2005.
- Arai, Toshifumi et al., Retrieving Electronic Documents with Real-World Objects on InteractiveDESK, *ACM*, pp. 37-38, Nov. 14-17, 1995.
- Armbrüster, Heinrich et al., "Broadband Multimedia Applications Using ATM Networks: High-Performance Computing, High-Capacity Storage, and High-Speed Communication", *IEEE Journal On Selected Areas In Communications*, Institute of Electronics and Electrical Engineers, vol. 10, No. 9, pp. 1382-1396, Dec. 1992.
- Ayre, Rick et al., "The Web Untangled", *PC Magazine*, Cover Story: Web Browsers, pp. 173-196, Feb. 7, 1995.
- Baker, Steven, "Hypertext Browsing On The Internet", *Unix Review*, Net Worth section, pp. 21-27, Sep. 1994.
- Balasubramanian, V., "State of the art review on hypermedia issues and applications", Graduate School of Management, Rutgers University, Newark, New Jersey, [Internet] csi.uottawa.ca/~dduchier/misc/hypertext, and isg.sfu.ca/~duchier.misc.hypertext_review.index.html, 40 pages, 1994.
- Bank, David, "The Road Ahead", Information Highway 101, Part one of three parts, *San Jose Mercury News*, Business Monday Section, pp. 1D, 4D-5D, Dec. 5, 1994.
- Bank, David, "Foundation for an Information Age" Information Highway 101, Part two of three parts, *San Jose Mercury News*, pp. 1A, 26A, 27A, Need Date, 1994.
- Bank, David, "Info Travelers Will Determine Highway's Look", Part one of three parts, *San Jose Mercury News*, pp. 1A, 13A, Need Date, 1994.
- Barclay Rebecca O., Virtual Blood, Real Sweat, No Tears: Lesson Learned from Making a Publication about electronic Publications', 1995 IEEE International Professional Communication Conference. IPCC 95 Proceedings, entitled Smooth Sailing to the Future, Savanna GA, USA, pp. 106-109, Sep. 27-29, 1995.
- Baser, K. et al., "On-Line Indexing Experiment at Chemical Abstract Service: Algorithmic Generation of Articulated Index Entries from Natural language Phrases", *J. Chem. Inf. Computer Science*, vol. 18, No. 1, pp. 18-25, 1978.
- "BBN could bulk up its Internet muscle", *Electronic Engineering Times*, pp. 89-90, Dec. 19, 1994.
- Beck, Bradley C., "An Interactive Forum for Convection-Diffusion Problems", The Second International Conference (94: Mosaic and the Web, Chicago, Ill, USA, 4 pages, Oct. 17-19, 1994.
- Berners-Lee, Tim, "Electronic publishing and visions of hypertext", *Physics World*, pp. 14-16, Jun. 1992.
- Berners-Lee, Tim et al., Hypertext Transfer Protocol—HTTP/1.0, Internet Draft, pp. 2-43, Dec. 19, 1994.
- Berners-Lee, Tim et al., "The World-Wide Web", *Communications Of The ACM*, vol. 37, No. 8, pp. 76-82, Aug. 1994.
- Berners-Lee, Tim et al., "World-Wide Web: The Information Universe", *Electronic Networking*, vol. 2, No. 1, pp. 52-58, Spring 1992.
- Bina, Eric et al., "Secure Access to Data Over the Internet", *Proceedings of the Third International Conference on Parallel and Distributed Information Systems*, Austin, Tx, USA, pp. 99-102, 1994.
- Björn, Michael, "An Interactive Relational Database Gateway with Load Balancing", *Proceedings '95 AUUG95 and APWWW95 Conference & Exhibition*, [Internet] edu.au/special/conference/apwww95/papers95/mbjorn/mbjorn.html, 10 pages, updated Jul. 2, 1997.
- Born, Gary, "a Knowledge Based Hypertext System for Document Generation and Checking", *IEE Colloquium on "Hypertext"*, Digest No. 142, Conference London, UK, 2/1-2/4, Nov. 2, 1990.
- Boutell, Thomas, "Techniques for Server-Side Dynamic Document Generation", The Second International WWW Conference (WWW'94: Mosaic and the Web), Chicago, Ill, USA, 5 pages, Oct. 17-19, 1994.
- Boutell, Thomas (Maintainer of web site), "World Wide Web FAQ", [Internet] sunrise.unc.edu/boutell/faq/www_faq.html, 39 pages, Updated Jan. 23, 1995.
- Bowman, C. Mic et al., "Harvest: A Scalable, customizable Discovery and Access System", *Technical Report CU-CS-732-94*, Dept. Computer Science, University of Colorado, pp. 1-27, Aug. 26, 1994.
- Brown, Marc H., "Browsing the Web with a Mail/News Reader", *ACM*, pp. 197-198, Nov. 14-17, 1995.
- Calliau, Robert, "A Little History of the World Wide Web", W3C® [Internet] 3.org/History.html, 6 pages, crated circa 1995.
- Chabrow, Eric R., "Online Employment", *Information Week*, pp. 38 etc. (3 pages Dialog printout), Jan. 23, 1995.
- Cinkosky, M. J. et al., "A New Design for the Genome Sequence Data Base", *IEEE Engineering in Medicine and Biology Magazine*, vol. 14, Issue 6, pp. 725-729, Nov.-Dec. 1995.
- Clark, Michele, "Net Force Gets Tough on Security", *Electronic Engineering Times*, pp. 96 & 98, Dec. 19, 1994.

- Clyde, Stephen et al., "An Object-oriented Implementation of an Adaptive Classification of Job Openings", *Proceedings of the 11th Conference on Artificial Intelligence for Applications*, Los Angeles, CA, USA, pp. 9-16, Feb. 20-23, 1995.
- Cohen, Ellis, S., "Review-Based Information Services: Lessons Learned from The Boston Restaurant List", The Second International WWW Conference (WWW'94: Mosaic and Web), Chicago, Ill, USA, 12 pages, Oct. 17-19, 1994.
- Cortese, Amy et al., "Cyberspace—The Software That Will Take You There", a Special Report in *Business Week*, pp. 78-89, Feb. 27, 1995.
- Crane, Michael L. et al., Marine Data Entry, *IEEE Proceedings OCEANS '83, vol. 1, Technical Papers*, San Francisco, CA, pp. 124-128, Aug. 29-Sep. 1, 1983.
- Davis Jim et al., "'Drop-in' publishing with the World Wide Web", The Second International WWW Conference (WWW'94: Mosaic and the Web), Chicago, Ill, USA, 9 pages, Oct. 17-19, 1994.
- Davison, Andrew, "Coding with HTML Forms", *Dr. Dobbs Journal*, pp. 71-75, Jun. 1995.
- Day John D. et al., "The OSI Reference Model", *Proceedings Of The IEEE*, vol. 71, No. 12, p. 1334-1340, Dec. 1983.
- Daynès, Laurent et al., "Locking in OODBMS Client Supporting Nested Transactions", *ICDE*, a publication of IEEE, pp. 316-323, 1995 (no month).
- Derfler, Frank J., Jr., "Betting on the Dream", *PC Magazine*, pp. 267-288, Oct. 25, 1994.
- Dolan, Donna R. et al., "Top U.S. Sources For An Online Job Search", *Database*, pp. 35-43, Oct./Nov. 1994.
- Dougherty, Elizabeth, Networks—Router Roundup and SNMP Catches On, *MacWorld*, p. 158, Dec. 1994.
- Dozier, Linda T., NaviPress and NaviServer: A Client-Server Publishing System for the World-Wide Web II, NaviSoft, an America Online Company, pp. 1-Index p. IV, Mar. 1995.
- Duncan, Ray, "Publishing Databases on the World Wide Web", *PC Magazine*, PC TECH/Power Programming, vol. 14. No. 21, pp. 403-412, Aug. 1995.
- Duncan, Ray, "Publishing HTML Forms on the Web", *PC Magazine*, PC TECH/Power Programming, vol. 14. No. 21, pp. 391-403, Dec. 5 1995.
- Duncan, Ray, "Setting Up a Web Server", *PC Magazine*, PC TECH/Power Programming, vol. 14, No. 9, pp. 273-280, May 16, 1995.
- Earthlink Launches Single-Solution Premium Web Site Package; [Internet] [.earthlink.net/about/press/pr_pwebsite/](http://earthlink.net/about/press/pr_pwebsite/), Mar. 12, 1997.
- Earthlink Launches the World's First Virtual "Theme" Room with Dilbert, Peanuts, and More; [Internet] [.earthlink.net/aboutpress/pr_elnroom/](http://earthlink.net/aboutpress/pr_elnroom/), Mar. 9, 1998.
- Earthlink Network's New Personal Start Page Actually Takes You Where You Want to Go, [Internet] earthlink.net/about/press/pr_psp/, Oct. 6, 1997.
- Eichmann, David et al., "Integrating Structured Databases Into the Web: The MORE System", The First International Conference on the World-Wide Web (WWW'94), Cern, Geneva, May 25-27, 1994 also published in *Computer Networks and ISDN Systems*, vol. 27, No. 2, pp. 281-288, Nov. 1994.
- Fernandez, Eduardo B. et al., *Database Security and Integrity*, Addison-Wesley Publishing Company, 1981.
- Flynn, Laurie, "The Executive Computer: Browsers Make Navigating The World Wide Web a Snap", *New York Times*, Sunday, Late Edition—Final, Section 3, p. 6, col. 1, Business/Financial Desk, Jan. 29, 1995.
- Frank, Maurice, "Database and the Internet", *DBMS Online* [Internet] dbmsmag.com/fl19512.html, 15 pages, Dec. 1995.
- Freeman-Benson, Bjorn N., "Using the Web to Provide Private Information-or-A Short Paper About Password Protection Without Client Modifications", The First International Conference on the World-Wide Web (WWW'94), Cern, Geneva, May 25-27, 1994.
- Frentzen, Jeff, "Low-cost Windows tools fill in Internet gaps", *PC Week*, p. 19, Dec. 12, 1994.
- Frentzen, Jeff et al., "Setting Up Shop on the Internet", *Windows Sources*, pp. 64-143, Feb. 1995.
- Frentzen, Jeff, "SQL databases, Web servers make connection", *PC Week*, vol. 12, No. 9, Mar. 6, 1995.
- Frentzen, Jeff, "The mystery of Common Gateway Interface", *PC Week*, vol. 12, No. 20, p. 13, May 22, 1995.
- Friold, Thane J. et al., "Extending WWW for Synchronous Collaboration", The Second International WWW Conference (WWW'94: Mosaic and the Web), Chicago, Ill, USA, [Internet] nca.uiuc.edu/SDG/IT94/Proceedings/CSCW, 5 pages, Oct. 17-19, 1994.
- Gee, David A. et al., "MosaicForms Database Access?: A Palaeobotanic case study", The Second International WWW Conference (WWW'94: Mosaic and the Web), Chicago, Ill, USA, [Internet] [.nca.uiuc.edu/SDG/IT94/Proceedings/GenSci/gee/pfrwww.html](http://nca.uiuc.edu/SDG/IT94/Proceedings/GenSci/gee/pfrwww.html), 8 pages, Oct. 17-19, 1994.
- Gilster, Paul, *The Internet Navigator*, John Wiley & Sons, Inc., Cover Page—p. 470, 1993.
- Google Groups Search results for "common gateway interface", Google, Inc., 20 pages, originally executed 2002, reexecuted Feb. 21, 2005.
- Google Groups Search results for author:usx@spud.hyperion.com, for email thread to Announce: The Used Software Exchange Google, Inc., 4 pages, Oct. 1994.
- Greenfield, David, "Radware Linkproof", *Network Magazine*, [Internet] [//newworkmagazine.com/shared/article/showArticle.jhtml?article=8702642](http://newworkmagazine.com/shared/article/showArticle.jhtml?article=8702642), 2 pages, Dec. 1, 1999.
- Grunin, Lori, "Publish Without Paper", *PC Magazine*, Cover Story, pp. 110-171, Feb. 7, 1995.
- Gunn, Angela, "Power in pictures: a Web-page primer: easier than it looks; World-Wide Web; includes related article on how to read Uniform Resource Locators", *Computer Shopper*, vol. 14, No. 11, p. 598 etc. (6 pages total), Nov. 1994.
- Gutierrez, Dan D., "Link the Web with Your Relational Databases", *Data Based Advisor*, Section-The Internet, WebDBC, 2 pages, Aug. 1995.
- Halama, James R. et al., "An Interactive Electronic Bulletin Board Implementation For Mosaic and HTTP Server", The Second International WWW Conference (WWW'94: Mosaic and Web), Chicago, Ill, USA, [Internet] [.nca.uiuc.edu/SDG/IT94/Proceedings/CSCW/halama/halama.html](http://nca.uiuc.edu/SDG/IT94/Proceedings/CSCW/halama/halama.html), 4 pages, Oct. 17-19, 1994.
- Halasz, Frank et al., "The Dexter Hypertext Reference", *Communications of the ACM*, vol. 37, No. 2, pp. 30-39, Feb. 1994.
- Harrington, Michael, "Mosaic: Door to the On-Line World", *Uniform Monthly*, pp. 20-26, Oct. 1994.
- Hastings, Edwin E. et al., "Providing Customers Information Using the WEB and CORBA", The Second International WWW Conference (WWW'94: Mosaic and the Web), Chicago, Ill, USA, [Internet] nca.uiuc.edu/SDG/IT94/Proceedings/DDay/hastings/hastings.html, 10 pages, Oct. 17-19, 1994.

- Haycox, Jamie, "Standard Generalized Markup Language (SGML) as a basis for an intelligent Data Management System", *Aerospace and Electronics Conference. NAECON*, Dayton, Ohio, also published in *Proceedings of the IEEE*, vol. 2, pp. 1017-1020, May 24-28, 1993.
- Heffron, Gordon, "Teleconferencing comes of age", *IEEE Spectrum*, pp. 61-66, Oct. 1984.
- Hughes, David, *Mini SOL—A Lightweight Database Engine*, Bond University, Australia, Version 1.0, Dec. 1994, Patch level: Patch 1, Jan. 1995, 21 pages.
- Hughes, Kevin, "Entering the World—Wide Web: A Guide to Cyberspace", Version 6.1, 29 pages, May 1994.
- Jacobsen, Lynn et al., "Providing Access to a Data Library: SQL and Full-Text IR Methods of Automatically Generating Web Structure", The Second International WWW Conference (WWW'94: Mosaic and the Web, Chicago, Ill, USA, [Internet] nicsa.uiuc.edu/SDG/IT94/Proceedings/SocialSci/jacobsen/jacobsen.html, 4 pages, Oct. 17-19, 1994.
- James, Edward, "Media and Hypermedia", *IEE Colloquium on 'Large Database in Press and Publishing: the Present and the Future'*, London, UK, pp. 6/1-6/2, Jun. 12, 1990.
- Jennings, Donald, et al., "How to Present Lots of Volatile Information on the World Wide Web", The Second International WWW Conference (WWW'94: Mosaic and the Web, Chicago, Ill, USA, [Internet] <http://www.nicsa.uiuc.edu/SDG/IT94/Proceedings/Astronomy/jennings.html>, 7 pages, Oct. 17-19, 1994.
- Johnson, Tony, "Spinning the World Wide Web", *Beam Line*, pp. 2-9, Fall 1994.
- Jones, Kennie H., "TOPS On-Line—Automating the Construction and Maintenance of HTML Pages", The Second International WWW Conference (WWW'94: Mosaic and the Web, Chicago, Ill, USA, [Internet] nicsa.uiuc.edu/SDG/IT94/Proceedings/Autools/jones/kjones/paper.html 7 pages, Oct. 17-19, 1994.
- Jones, Russ, "Digital's World-Wide Web Server: A Case Study", First International Conference on the World-Wide Web, Cern, Geneva, Switzerland, 10 pages, May 1994.
- Keizer, Gregg, "Accessing the Internet", *Computer Shopper*, pp. 533-545, Jan. 1995.
- Kelly, C. W., "An Enhanced Presence Video Conferencing System", *Proceedings Computer Networks (COMPCON Fall '82)*, IEEE Computer Society, pp. 545-551, Sep. 20-23, 1982.
- Knowles, Anne, "Information Highway—ATM carriers outpace demand for fast data links", *PC Week* vol. 12, No. 5, front page and p. 125, Feb. 6, 1995.
- LaLiberte, Daniel et al., "A Protocol for Scalable Group and Public Annotations", [Internet] hypernews.org/~liberte/www/scalable-annotations.html, 9 pages, The Third International World-Wide Web Conference, (www'95), Darmstadt, Germany, 9 pages, Apr. 12, 1995.
- Lawton, Stephen, "Internet reveals its commercial potential", *digital news & review*, pp. 36-37, Sep. 12, 1994.
- Lemay, Laura, *Teach Yourself Web Publishing with HTML in a Week*, Sams Publishing, First Ed., pp. i-403, 1995.
- Lemay, Laura, *Teach Yourself More Web Publishing with HTML in a Week*, Sams.net, First Ed., pp. 1-449, 1995.
- Lewis, Peter H., "Prodigy Leads Its Peers Onto the World Wide Web", *The New York Times*, Section D, p. 7, Col. 1, Business/Financial Desk, Jan. 18, 1995.
- Linde, Peter L, HTML and MOSAIC: A taste for more *INET94 Proceedings*, Prague, Czech Republic, 8 pages, Jun. 13-17, 1994.
- Liu, Jinhui et al., *Description and Recognition of Form and Automated Form Data Entry*, vol. 2, pp. 579-582, Aug. 14-16, 1995.
- Lynch, Russ, "Outrigger on-line with travel info", *Starr-Bulletin*, 1 page, circa Nov. 1994.
- Mamrak, Sandra A. et al., "Benefits of Automating Data Translation", *IEEE Software*, vol. 10, Issue 4, pp. 82-88, Jul. 1993.
- Marcus, Aaron et al., "User-Interface Developments for the Nineties", *IEEE Computer*, pp. 49-57, Sep. 1991.
- Mariott, Michael et al., *Super Cyber Surfers—The Web: How to get around the most fun place on the Internet*, *Newsweek*, pp. 43-44, Mar. 20, 1995.
- McArthur, Douglas C., "World Wide Web & HTML", *Dr. Dobb's Journal*, vol. 19, No. 15, pp. 18-23, Dec. 1994.
- McGee, Marianne Kolbasuk, "Help Wanted? Find it online; JobTrak is just one new service making both job hunting and recruitment easier", *Information Week*, 1995, No. 531, p. 84(1), Jun. 12, 1995.
- MCI Employment Advertisement using Resume Builder, [Internet] mci.com/cgi-bin-display-cg...data/main.jobs.previews.add-85699005.job, 32 pages, no date, printed Apr. 29, 1997.
- McKee, Douglas, "Towards Better Integration of Dynamic Search Technology and the World-Wide Web", The First International Conference on the World-Wide Web (WWW'94), Cern, Geneva, 7 pages, May 25-27, 1994.
- Morton, Sanford, "A Tour of HTML Forms and CGI Scripts", CGI Resources, [Internet] jalix.org/ressources/internet/cgi/~perl/cgi/form&cgi-tour.html, 11 pages, Last modified Aug. 16, 1998, printed Feb. 21, 2005.
- Mueller, B, "Implementation of the Information System", The Second International WWW Conference (WWW'94: Mosaic and the Web, Chicago, Ill, USA, [Internet] archive.nicsa.uiuc.edu/SDG/IT94/Proceedings/Educ/mueller/Implementation.html, 3 pages.
- Müller, Bernd, "Using World Wide Web as an information system to reduce the average period of study by better information providing and to relieve administration", The Second International WWW Conference (WWW'94: Mosaic and the Web, Chicago, Ill, USA, [Internet] nicsa.uiuc.edu/SDG/IT94/Proceedings/Educ/mueller/Paper.html, 10 pages, Oct. 17-19, 1994.
- Nesbitt, Kenn, "Data Entry on the World Wide Web: Part 2", *Data Base Advisor*, pp. 84-86, 90-93, Aug. 1995.
- Ng, Jason, "GSQL—a Mosaic—SQL gateway", [Internet] nicsa.uiuc.edu/SDG/People/jason/pub/gsql/starthere.htm, University of Ill., 2 pages, 1994.
- Ng, Jason, GSQL in detail, [Internet] nicsa.uiuc.edu/SDG/People/jason/pub/gsql/howto.html, University of Ill., 3 pages, 1994.
- Ng, Jason, "GSQL PROC file commands" [Internet] nicsa.uiuc.edu/SDG/People/jason/pub/gsql/proc-tmt.html, University of Ill., 7 pages, 1994.
- Ng, Jason, "New Mosaic-SQL interface" [Internet] nicsa.uiuc.edu/SDG/People/jason/pub/gsql/sampleform.html, University of Ill., 2 pages, 1994.
- Ogle, David M. et al., "Dynamically Selecting Protocols for Socket Applications", *IEEE Network* pp. 48-57, May 1993.
- Paoli, Jean, "Cooperative Work On the Network: Edit the WWWI", *Proceedings of the Third International World Wide Web Conference*, [Internet] igd.fhg.de/www/www95/proceedings/papers/76/paper.html, also published by Computer Networks and ISDN systems, pp. 841-847, Apr. 1995.

- Patton, Phil, "Life On The Net", *Esquire*, pp. 131-138, Dec. 1994.
- Peters, Ralph et al., "CrystalWeb-A distributed authoring environment for the World-Wide Web", Proceedings of the Third International World-Wide Web Conference, Apr. 10-14, 1995, Darmstadt, Germany also published in *Computer Networks and ISDN Systems*, vol. 27, pp. 861-870, 1995.
- Pferd, William et al., "Special Feature: Interactive Graphics Teleconferencing", *IEEE Computer*, pp. 62-72, Nov. 1979.
- Pierog, Karen, "Ohio—Greater Columbus Freenet", publication unknown, 1 page, circa Feb. 22, 1995.
- Postel, J, et al., "White Pages Meeting Report", Network Working Group, Request for Comments: 1588, [Internet] pmg.lcs.mit.edu/cgi-bin/rfc/view-plain?number=1588, 29 pages, Feb. 1994.
- Powell, James, "Adventures With The World Wide Web-Creating A Hypertext Library Information System", *Database*, pp. 59-66, Feb. 1994.
- Prah, Chris et al., "Mosaic as Corporate Data Collector and Dispenser", The Second International WWW Conference (WWW'94: Mosaic and the Web, Chicago, Ill, USA, [Internet] ncsa.uiuc.edu/SDG/IT94/Proceedings/CorInfSys/prah/phah.html 4 pages, Oct. 17-19, 1994.
- Preece J., "Survival of the Fittest: The Evolution of the Multimedia User Interface", *ACM Computing Surveys*, vol. 27, No. 4, pp. 57-559, Dec. 1995.
- Press L., "The Internet and the Travel Industry", *Proceedings of ENTER '95*, [Internet] [/som.csudh.edu/cis/lpress/travel.htm](http://som.csudh.edu/cis/lpress/travel.htm), Innsbruck, Austria, 11 pages, Jan. 18-20, 1995.
- Putz, Steve, "Interactive Information Services Using World-Wide Web Hypertext", The First International Conference on the World-Wide Web (WWW'94), Cern, Geneva, Switzerland, May 25-27, 1994.
- Raeder, Aggi, "Internet World '95 in San Jose", *Searcher: The Magazine for Database Professionals*, p. 10, 12, 14, 16,-18, May 1995.
- Ramsay, Martin L., "The USA at Your Fingertips", *Computer Graphics World*, vol. 16, No. 6, p. 81(1), Jun. 1993.
- Randall, L. Scott, "The Shared Graphic Workspace: Interactive Data Sharing In A Teleconference Environment", *Proceedings Computer Networks (COMPCON Fall '82)*, IEEE Computer Society, pp. 535-542, Sep. 20-23, 1982.
- Rasmussen, B. F., "WDB-A Web Interface to Sybase", *Astronomical Data Analysis Software And Systems IV*, ASP Conference Series, vol. 77, pp. 72-75, 1995.
- Resumix Product Announcement: Resume: Resumix announces Internet service for building effective scannable resumes on-line (Resume Builder), *Edge: Work-Group Computing Report*, vol. 6, No. 264, 3 pages, Jun. 12, 1995.
- Riley, Margaret F., "Resume Databases on the Internet", *The Riley Guide*, 5 pages, Jan. 20, 1997.
- Rodgers, R. P. Channing et al., "On-Line Images from the History of Medicine (OLI): Creating a Large Searchable Image Database for Distribution via World-Wide Web", *Proceedings of the First International World-Wide Web Conference*. Geneva, May 25-27, 1994: 423-431 (paper available at: nlm.nih.gov/hmd.dir/oli.dir/paper/paper.html: system available at: nlm.nih.gov/hmd.dir/oli.dir/).
- Rosenking, Jeffrey P. et al., "A Generic system for Directory Pagination", *Proceedings of the IEEE/ACM International Conference on Developing and Managing Expert System Programs*, pp. 166-169, Sep. 20-Oct. 2, 1991.
- Rosenthal, Steve, "Mega Channels", pp. 36-46, Sep. 1993. (pp. 36 & 37 missing from copy).
- Rousseau, B., "Publishing on the Web", Presented at the CERN School of Computing, Aries, France, pp. 279-293, Aug. 20-Sep. 2, 1995.
- "Royalty Demands Anger Firms", *San Jose Mercury News*, 1 page, unknown date.
- Saal, Harry J., "Think the info highway is great? Baby, you ain't seen nothing yet", *San Jose Mercury News*, Business Monday, p. 4D, unknown date.
- Scharf, Ronald et al., "Using Mosaic for Remote Test System Control Supports Distributed Engineering", The Second International WWW Conference WWW'94: Mosaic and the Web, Chicago, Ill, USA, [Internet] ncsa.uiuc.edu/SDG/IT94/Proceedings/CSCW/scharf/scharf.html, 8 pages, Oct. 17-19, 1994.
- Schroeder, Michael D., "A State-of-the-Art Distributed System: Computing with BOB", appears in Chapter 1, *Distributed Systems*, Addison-Wesley/ACM Press, 1993 (no month).
- Stefanac, Suzanne, Surfing the TeleNet in 2008, *NewMedia*, pp. 40-41, Sep. 1993.
- Story, Guy A. et al., "The RightPages Image-Based Electronic Library for Alerting and Browsing", *COMPUTER*, vol. 25, No. 9, pp. 17-26, Sep. 1992.
- Sullivan, Kristina B, "Vendors to push multimedia wares at CD ROM show" at CD-ROM Expo in Washington D.C., *PC Week*, vol. 8, N40, p. 28, Oct. 7, 1991.
- "Sun joins \$1 billion alliance", *San Jose Mercury News*, 1 page, unknown date.
- Suryaraman, Maya, "Internet access for schools is nearer", *San Jose Mercury News*, pp. 1A and Back Page, date unknown.
- Tanaka, Jennifer et al, "A (Free and) Easy Guide to the Web", *Newsweek*, p. 44, Mar. 20, 1995.
- Thomas, Christoph G., "BASAR: A framework for integrating agents in the World Wide Web" *IEEE Computer*, pp. 84-86, May 1995.
- Towsend, Carl et al., *Microsoft Office/Access*, QUE Computer Publishing, pp. 615-618, 646-658. 670-679, 1994 (no month).
- Varela, Carlos A. et al., "Providing Data on the Web: From Examples to Programs", The Second International WWW Conference (WWW'94: Mosaic and the Web, Chicago, Ill, USA, [Internet] ncsa.uiuc.edu/SDG/IT94/Proceedings/SDG/IT94/Dday/varela/paper.html, 10 pages, Oct. 17-19, 1994.
- Varela, Carlos A. et al., "Zelig: Schema—Based Generation of Soft WWW Database Applications", The First International Conference on the World-Wide Web (WWW'94), Cern, Geneva, May 25-27, 1994.
- Veljkov, Mark et al., *Pocket Guides To The Internet: vol. 2: Transferring files With File Transfer Protocol*, Mecklermedia, pp. 11-17, 1994.
- Verity, John W. et al., "How the INTERNET will change the way you do business", *Business Week*, Cover Story, pp. 80-88, Nov. 14, 1994.
- Volpentesta, A, "A Multimedia Bulletin Board in WWW environment", The Second International WWW Conference (WWW'94: Mosaic and the Web, Chicago, Ill, USA, [Internet] ncsa.uiuc.edu/SDG/IT94/Proceedings/CSCW/volpentesta/giuda.html, 4 pages, Oct. 17-19, 1994.
- Wagner, Mitch, "Law Firm's Verdict On Internet Is Unanimous", *Open Systems Today*, pp. 84-85, Nov. 28, 1994.
- Weibel, Stuart et al, "An Architecture for Scholarly Publishing on the World Wide Web", The Second International

WWW Conference (WWW'94: Mosaic and the Web), Chicago, Ill, USA, [Internet] archive.ncsa.uiuc.edu/SDG/IT94/Proceedings/Pub/weibel/weibel_www_paper.html, 7 pages, Oct. 17-19, 1994.

Welch, Peter D. et al., The Internet's World Wide Web and the Simulation Community A Surfing Lesson for Beginners, *ACM*, pp. 1329-1332, Winter 1995.

Whitehead, Steven D., "Auto-FAQ: an experiment in cyberspace leveraging", The Second International WWW Conference (WWW'94: Mosaic and the Web), Chicago, Ill, USA, [Internet] archive.ncsa.uiuc.edu/SDG/IT94/Proceedings/Agents/whitehead/whitehead.html, 5 pages, Oct. 17-19, 1994.

Willard, K. E. et al., "W3 Based Medical Information Systems vs Custom Client Server Applications", The Second International WWW Conference (WWW'94:

Mosaic and the Web), Chicago, Ill, USA, [Internet] archive.ncsa.uiuc.edu/SDG/IT94/Proceedings/UMHC_www/UMHC_paper.html, 10 pages, Oct. 17-19, 1994.

Yamamoto, Kazu, "(Ipng 7052) new multi-home technologies", [Internet] cs-ipy6.lancs.ac.uk/ipv6/mail-archive/1Png/1999-02/0045.html, 7 pages, Jan. 13, 1999, printed Feb. 16, 2005.

Young, Degi et al., "A Graphical Filter/Flow Representation of Boolean Queries: A Prototype Implementation and Evaluation", *Journal of the American Society for Information Science (JASIS)*, vol. 44, No. 6, 327-339, Jul. 1993.

Young, Stephen et al., *Claris MacProject® II*, pp. 1-137, unknown date.

* cited by examiner

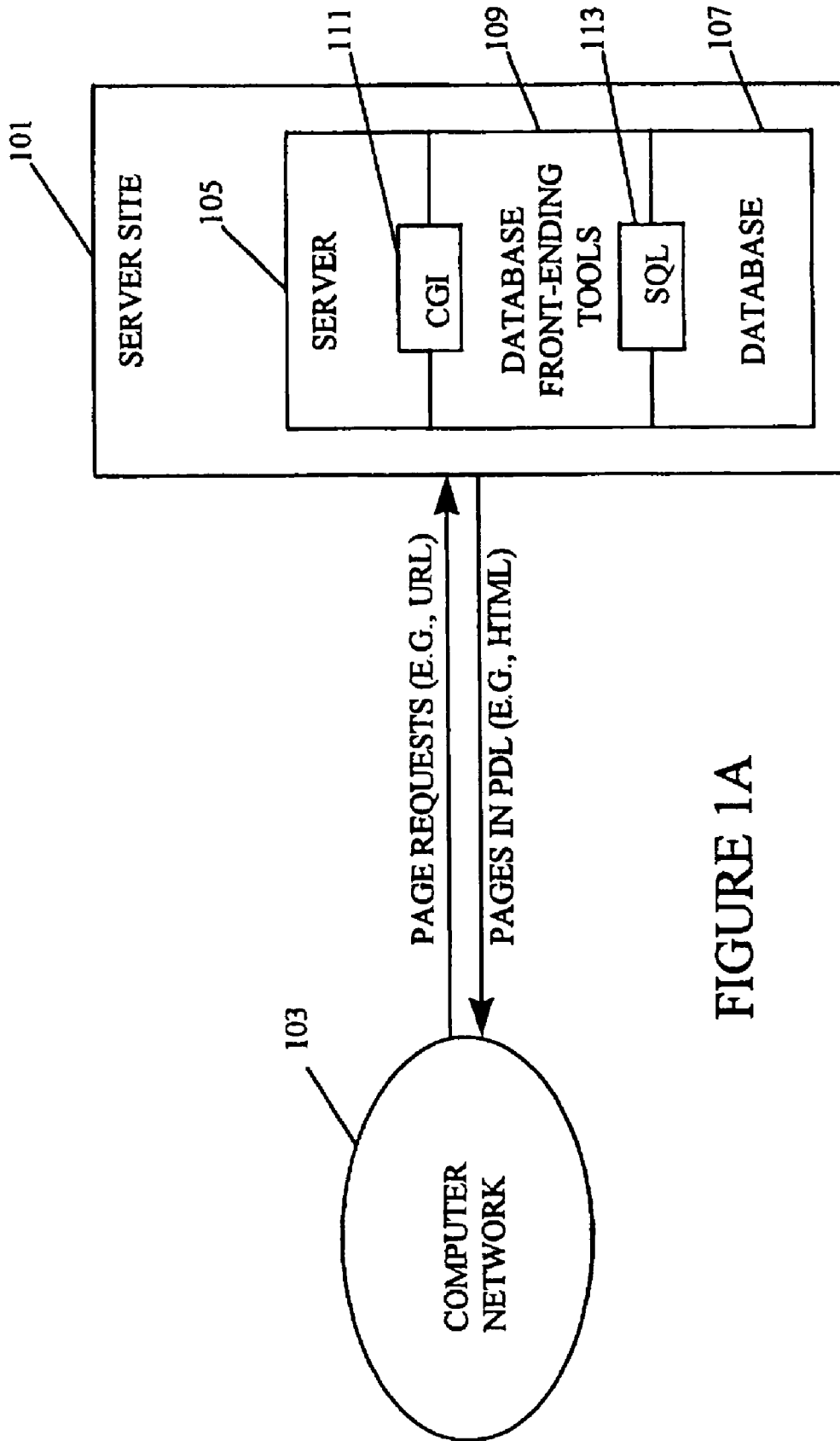

FIGURE 1A

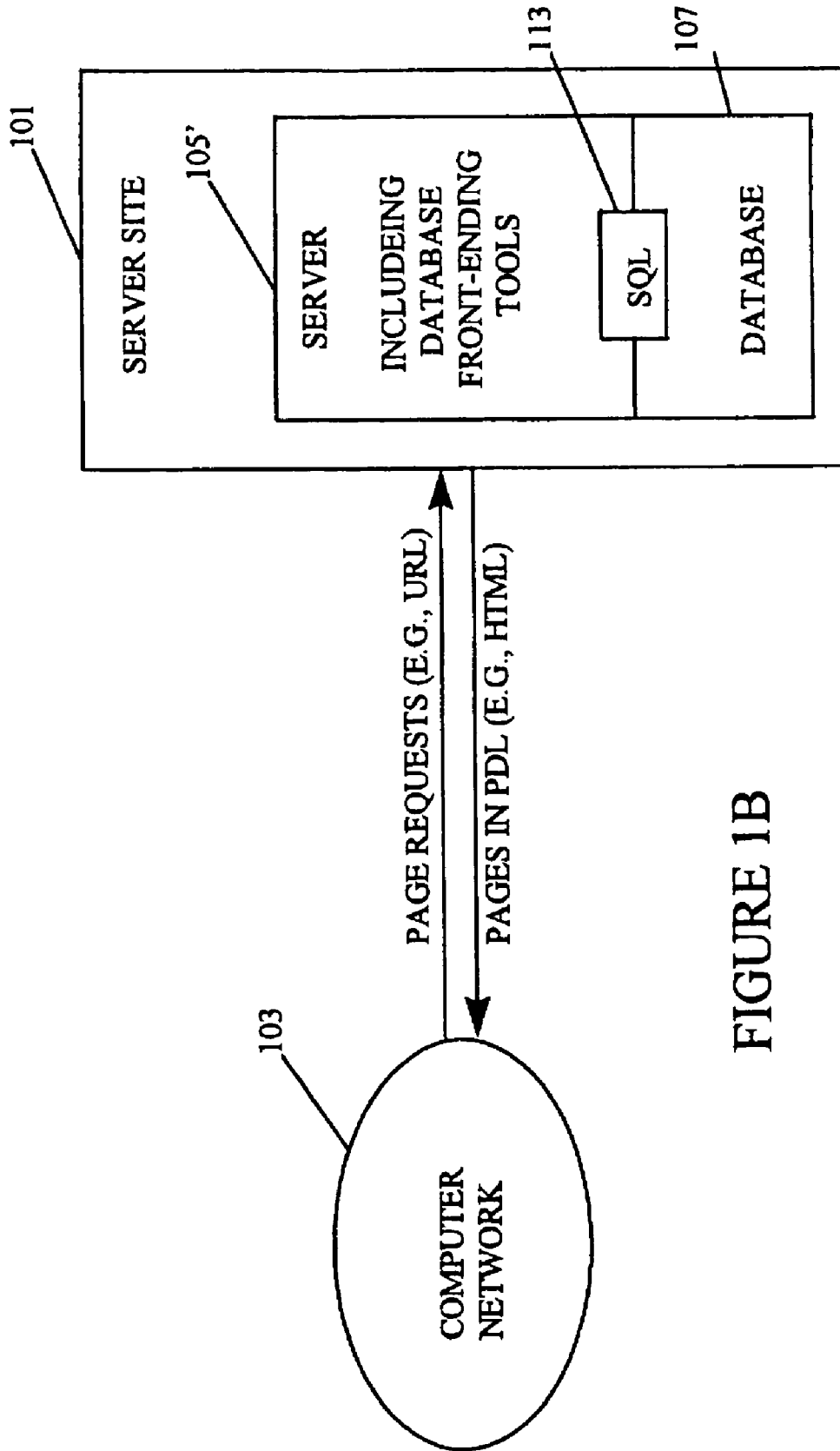
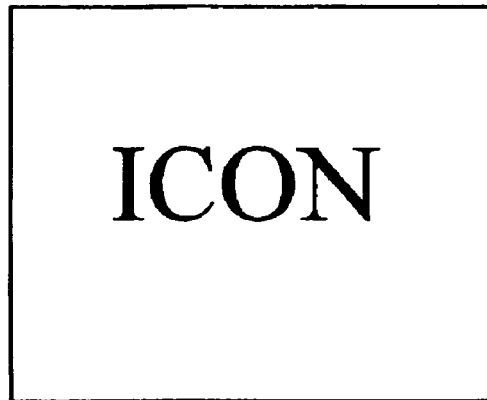

FIGURE 1B



The who's who of the World Wide Web



> WebBook

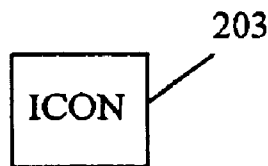

> Whois



> Traceroute

This page is brought to you by the guys from _____ . Intelligent Computing for the Internet from The Internet Solution Provider.
(C)1995 SRMC.

FIGURE 2A



WebWho's Whois

This is a WWW front end to the United States Whois database

Valid Entry Type	Example...
Domain Name	
Machine Name	
Registered Handle	
Registered Name	
IP Address	
IP Network	

209

Information to lookup:

← 211

FIGURE 2B

Scientific Research Management Corp. (SRMC-DOM)
1714 Ringwood Avenue
San Jose, CA 95131

Domain Name: SRMC.COM

Administrative Contact:

Lyke, Howie (HL39) (No mailbox)
408 437-1800

Technical Contact, Zone contact:

Coley, Chris (CC339) ccoley@SRMC.COM
408 437-1800

215



213



Record last update on 04-Jun-95
Record created on 13-Dec-94

Domain servers in listed order:

NS.SRMC.COM	205.138.192.10
CASD.SRMC.COM	205.138.192.252
SWEB.SRMC.COM	205.138.192.253
SMAIL.SRMC.COM	205.138.192.254

The InterNIC Registration Services Host contains ONLY Internet information (Networks, ASN's, Domains, and POC's). Please use the whois server at nic.ddn.mil for MILNET Information.

FIGURE 2C

Navigational Aid

ICON

WebBook

ICON

Whois

ICON

Traceroute

ICON

WebWho



This page is brought to you by the guys from ____.
Intelligent Computing for the Internet from The
Internet Solution Provider.
(C) 1995 SRMC.

FIGURE 2D

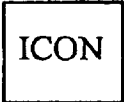

WebWho's Traceroute

This is a WWW front end to the Traceroute utility
Enter the hostname or an address to trace a route to.

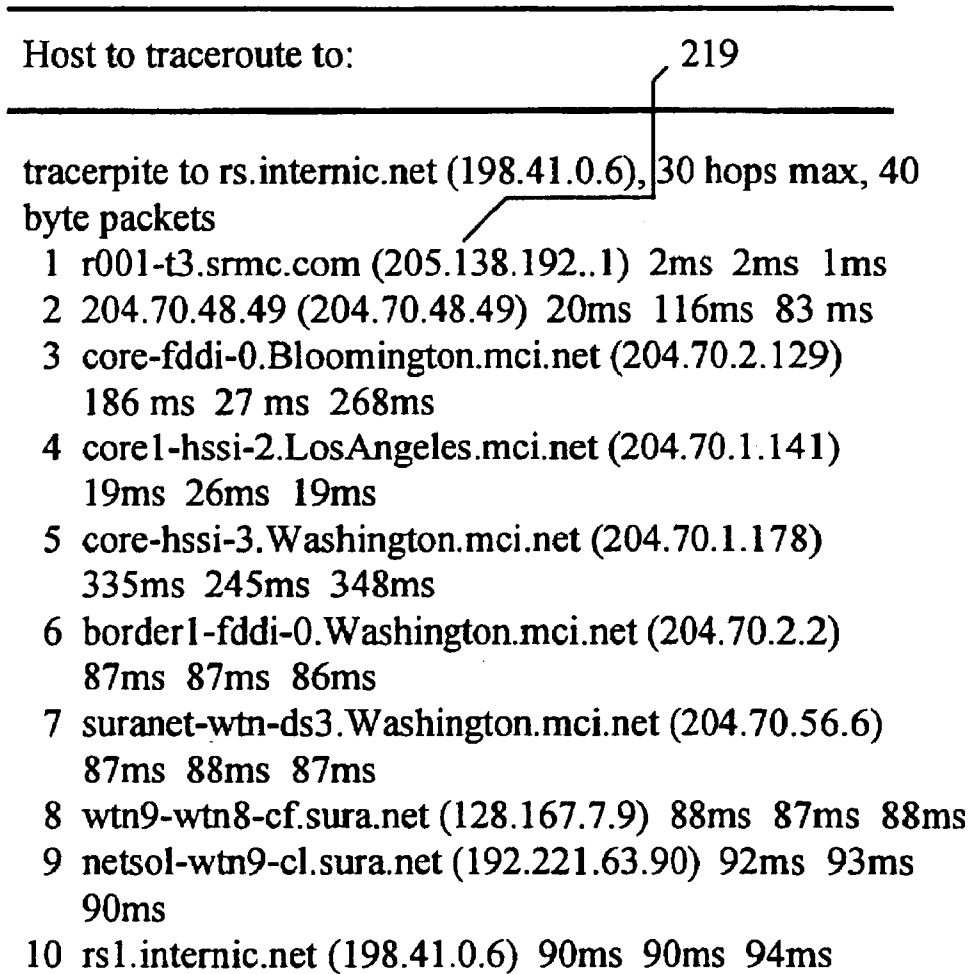

FIGURE 2E

Navigational Aid

ICON	WebBook
ICON	Whois
ICON	Traceroute
ICON	WebWho

This page is brought to you by the guys from ____.
Intelligent Computing for the Internet from The
Internet Solution Provider.
(C) 1995 SRMC.

FIGURE 2F

WebBook

- Search
 - Add
 - Update
 - Change password
 - Login
-
-

FIGURE 2G

Searching

- Categories - Search by going through the categories list
 - Example - Search by querying each field of the entries
 - Keyword - Search by specifying a keyword
-
-

- MAIN - SEARCH - ADD - UPDATE

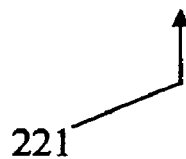

FIGURE 2H

Choose a category

- BUSINESS - COMMERCIALS, FINANCE....
 - RECREATION - recreation stuffs.
 - WEBWHO95 -
-

Display how many entries at a time?

- MAIN - SEARCH - ADD - UPDATE

FIGURE 2I

Choose a category

WEBWHO95

Sub-categories:

INDEX -

Display how many entries at a time?

9250 entries available!

9240 entries more

- Topographical Pictures
 - Xtoys
 - Index - The SoftSource Files
 - Computer ESP
 - Against Computer/Video Games
 - Arrgh! The Entertainment Page
 - CD-ROM Network
 - Complete Gaming HeadQuarters
 - Digital Nostalgia
 - EINet's Gaming Resource
-
-

- MAIN - SEARCH - ADD - UPDATE

FIGURE 2J

Enter any field you want to search

Title:

First Name: Last Name:

Middle Name: (optional)

Phone#:

Address:

City: State:

Zipcode: Country:

Email:

URL:

Display how many entries at a time?

- MAIN - SEARCH - ADD - UPDATE

FIGURE 2K

Submit a new entry to WebWho

Title: (The way you want your entry to appear in WebWho)

Name: (The way it appears on your credit card)

First Name: Last Name:

Middle Name:(optional)

Phone#1:

Phone#2(optional): Fax:(optional)

Address:

City: State:

Zipcode: Country:

Email:

URL#1:(optional)

URL#1:(optional)

Please enter your 20 keywords in the following text area.
Each keyword should not exceed 20 characters.
Remember to separate each keyword by space(s).

Enter a description of your entry in the following text area.
It will be displayed along with your entry.

- MAIN - SEARCH - ADD - UPDATE

FIGURE 2L

Choose a category

BUSINESS

- BOOKSTORE -STORE THAT SELLS BOOKS
 - COMPUTER -COMPUTER COMPANIES.
 - REAL ESTATE -BUYING AND SELLING PROPERTIES.
 - WEDDING DESIGN -PLAN AND CORRDATE WEDDINGS.
-

Or define your own

Category:

Description:

- MAIN - SEARCH - ADD - UPDATE

FIGURE 2M

ANNE HOGAN PERRY REALTOR

Anne brings to her clients the depth of her business background teamed with her strong commitment towards professionalism and client satisfaction. Anne view real estate as a team effort and partnership; her success stems from the success of her clients. Referrals from client were the key to Anne's achievement as Mary Worrall's Top Producer for 1994. Anne's focus areas have followed those of her clients. From the first time home buyer to high end sophisticated estate purchaser, all receive the same high levels of service and enthusiasm. Anne was born and raised on the "Gold Coast" of Oahu. Prior to moving back to Honolulu in 1993, she lived the past ten years on Maui and Kauai. Her Kamanina background teamed with her neighbor island exposure gives her a unique, in depth and first hand perspective on the statewide real estate market. Anne is one of the few brokers in Hawaii who has actively sold real estate on four islands.

Name: Perry, Anne H

Phone#1: 8087352411

Phone#2:

Fax:

Address: 4211 WALALAE AVENUE SUITE 100

City: HONOLULU State: HI

Zipcode:96816 Country: USA

FIGURE 2N

Email: aperry@warrall.com

URL#1: <http://www.worrall.com/estate/estate.shtml>

URL#2: <http://www.worrall.com/estate/estate.shtml>

○ - MAIN ○ - SEARCH ○ - ADD ○ - UPDATE

FIGURE 20

Edit your post, then press UPDATE

Title: (The way you want your entry to appear in WebWho)

Name: (The way it appears on your credit card)

First Name: Last Name:

Middle Name:(optional)

Phone#1:

Phone#2(optional): Fax:(optional)

Address:

City: State:

Zipcode: Country:

Email:

URL#1:(optional)

URL#1:(optional)

Please enter your 20 keywords in the following text area.

Each keyword should not exceed 20 characters.

Remember to separate each keyword by space(s).

Enter a description of your entry in the following text area.

It will be displayed along with your entry.

- MAIN - SEARCH - ADD - UPDATE

FIGURE 2P

**Press BACK to edit the keywords and comments again.
Otherwise, press the change button if you want to change
category, or press the done button to update your entry.**

The keywords you have entered are:

keyword1: HAWAII
keyword2: REALTOR
keyword3: HONOLULU
keyword4: REALESTATE
keyword5: OCEAN
keyword6: FRONT
keyword7: BROKER
keyword8: PROPERTIES
keyword9:
keyword10:
keyword11:
keyword12:
keyword13:
keyword14:
keyword15:
keyword16:
keyword17:
keyword18:
keyword19:
keyword20:

FIGURE 2Q

The following description will be displayed with your entry

Anne brings to her clients the depth of her business background teamed with her strong commitment towards professionalism and client satisfaction. Anne view real estate as a team effort and partnership; her success stems from the success of her clients. Referrals from client were the key to Anne's achievement as Mary Worrall's Top Producer for 1994. Anne's focus areas have followed those of her clients. From the first time home buyer to high end sophisticated estate purchaser, all receive the same high levels of service and enthusiasm. Anne was born and raised on the "Gold Coast" of Oahu. Prior to moving back to Honolulu in 1993, she lived the past ten years on Maui and Kauai. Her Kamanina background teamed with her neighbor island exposure gives her a unique, in depth and first hand perspective on the statewide real estate market. Anne is one of the few brokers in Hawaii who has actively sold real estate on four islands.



- Change categories - Done update



- MAIN - SEARCH - ADD - UPDATE

FIGURE 2R

Please enter the identification number of this post

identification number:

- MAIN - SEARCH - ADD - UPDATE

FIGURE 2S

Your post has been updated. Thank you!

- MAIN - SEARCH - ADD - UPDATE

FIGURE 2T

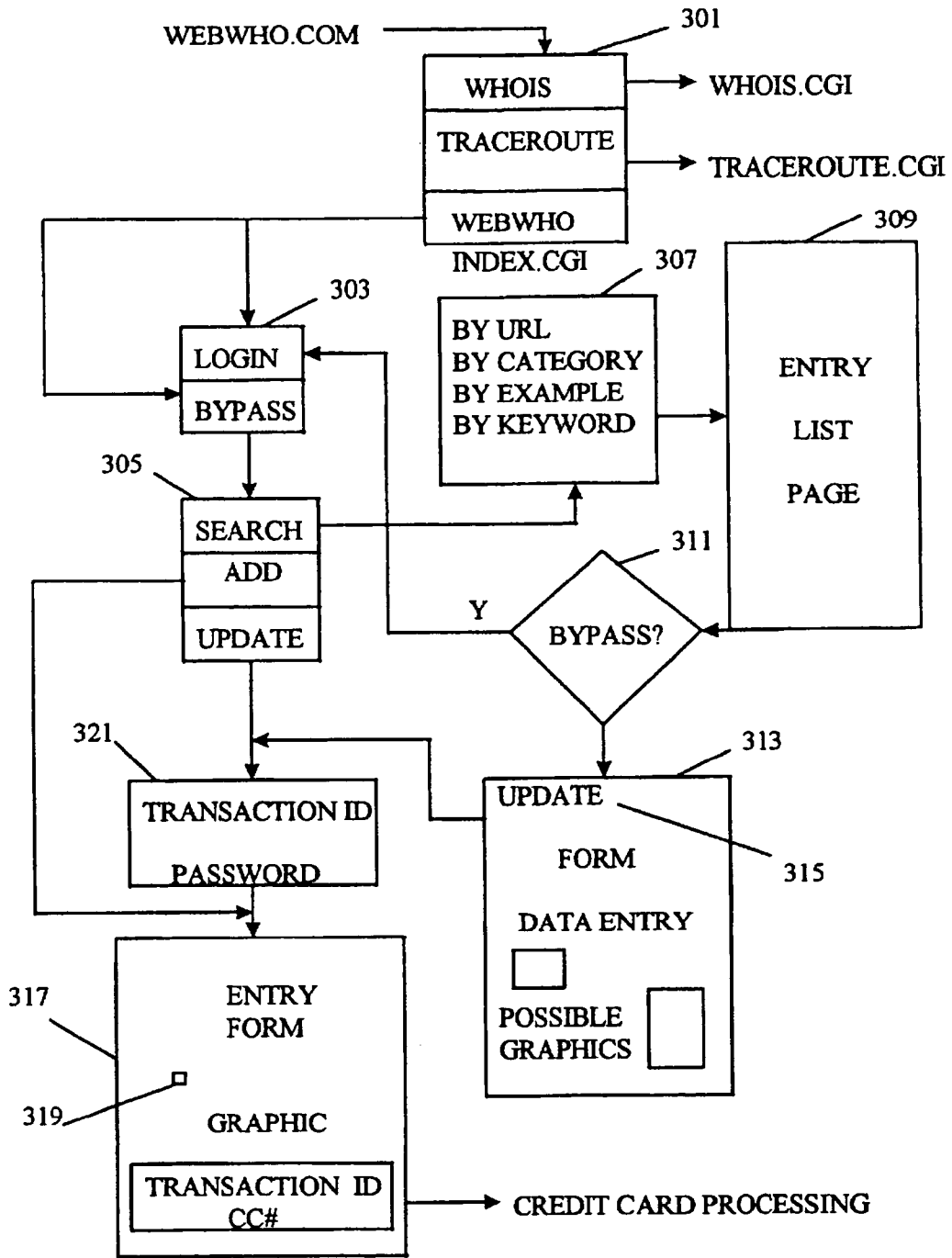

FIGURE 3

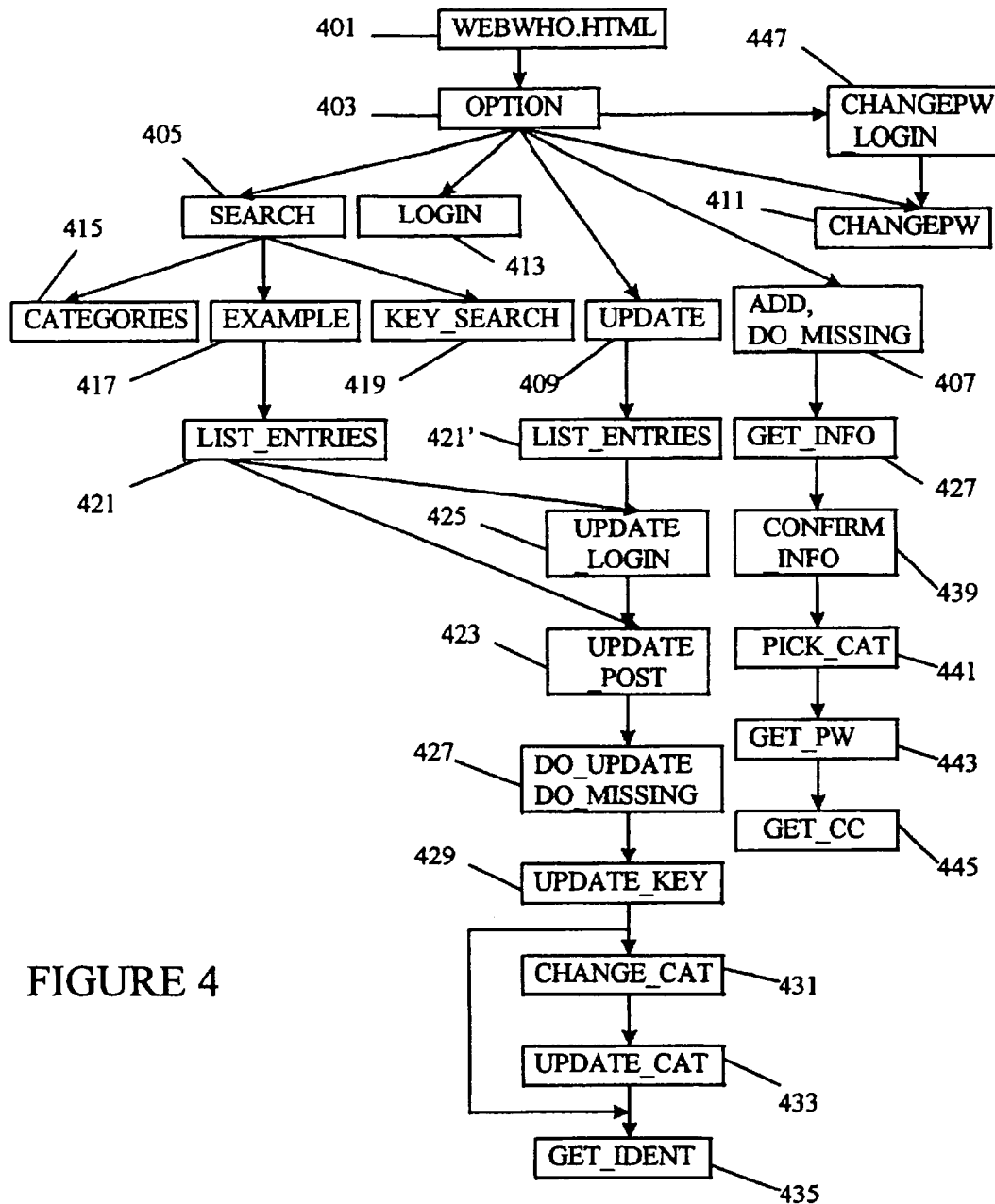

FIGURE 4

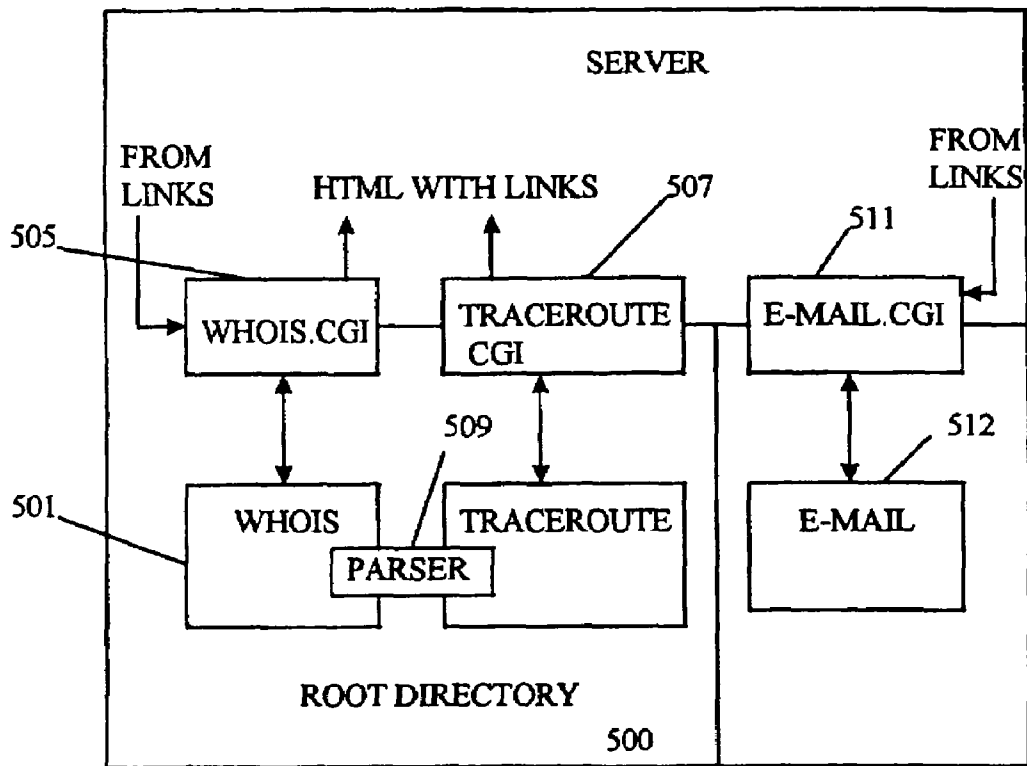

FIGURE 5

**METHOD AND APPARATUS FOR
PROVIDING A DYNAMICALLY-UPDATING
PAY-FOR-SERVICE WEB SITE**

CROSS-REFERENCE TO RELATED
APPLICATIONS

This application is a continuation of U.S. patent application Ser. No. 10/703,823, filed Nov. 7, 2003, which is a continuation of U.S. patent application Ser. No. 09/952,985, filed Sep. 14, 2001 now U.S. Pat. No. 6,850,940, which is a continuation of U.S. patent application Ser. No. 09/110,708, filed Jul. 7, 1998, now issued as U.S. Pat. No. 6,324,538, which is a continuation of U.S. patent application Ser. No. 08/572,543, filed Dec. 14, 1995, now issued as U.S. Pat. No. 5,778,367.

BACKGROUND OF THE INVENTION

1. Field of the Invention

The present invention relates to on-line services, particularly to services for the World Wide Web.

2. State of the Art

The Internet, and in particular the content-rich World Wide Web ("the Web"), have experienced and continue to experience explosive growth. The Web is an Internet service that organizes information using hypermedia. Each document can contain embedded reference to images, audio, or other documents. A user browses for information by following references. Web documents are specified in HyperText Markup Language (HTML), a computer language used to specify the contents and format of a hypermedia document (e.g., a homepage). HyperText Transfer Protocol (HTTP) is the protocol used to access a Web document.

Part of the beauty of the Web is that it allows for the definition of device-, system-, and application-independent electronic content. The details of how to display or play back that content on a particular machine within a particular software environment are left to individual web browsers. The content itself, however, need only be specified once. In some sense, then, the Web offers the ultimate in cross-platform capability.

Pre-existing collections of information, however, such as databases of various kinds, can rarely be placed directly on the Web. Rather, gateway programs are used to provide access to a wide variety of information and services that would otherwise be inaccessible to Web clients and servers. The Common Gateway Interface (CGI) specification has emerged as a standard way to extend the services and capabilities of a Web server having a defined core functionality. CGI "scripts" are used for this purpose. CGI provides an Application Program Interface, supported by CGI-capable Web servers, to which programmers can write to extend the functionality of the server. CGI scripts in large part produce from non-HTTP objects HTTP objects that a Web client can render, and also produce from HTTP objects non-HTTP input to be passed on to another program or a separate server, e.g., a conventional database server. More information concerning the CGI specification may be accessed using the following Universal Resource Locator (URL): <http://hoohoo.ncsa.uiuc.edu/cgi/interfac.html>

With the explosive growth of the Web, fueled in part by the extensibility provided by CGI scripts, the need for "finding aids" for the Web, i.e., tools to allow one to find information concerning a topic of interest, has grown acute. Many hardcopy volumes are presently available that are represented to be "White Pages" or "Yellow Pages" for the

Web. Of course, hard copy information becomes rapidly out of date, and in the case of the Web, is out of date before it is even printed (let alone distributed), in the sense of failing to list many interesting resources newly made available on the Web.

The only effective solution is to have such finding aids be on-line, available on the Web itself. One such finding aid is a class of software tools called search engines. Search engines rely on automated Web-traversing programs called robots or spiders that follow link after link around the Web, cataloging documents and storing the information for transmission to a parent database, where the information is sifted, categorized, and stored. When a search engine is run, the database compiled through the efforts of the robots and spiders is searched using a database management system. Using keywords or search terms provided by the user, the database locates matches and possibly near-matches as well.

An example of one such search engine is known as Yahoo, offered by Yahoo! Corporation of Mountain View, Calif., and may be accessed at the URL <http://www.yahoo.com>. Persons having pages on the Web, rather than simply waiting to have their Web page be found by a robot or spider, can also have their Web page listed in the Yahoo database by providing information concerning the resource they wish to list and paying a fee. The result is an on-line-searchable directory of Web resources that is regularly updated.

While such services are indeed extremely useful, nevertheless, from the standpoint of a person wishing to publicize their Web site, they are typically attended by a number of drawbacks. In particular, the person wishing to publicize their Web site typically has very limited control of the content of the resulting listing. Submissions, including textual description and suggested categories, are often subjected to editorial control that may range from strict to arbitrary. As a result, a listing may be placed under an entirely different category from the category intended by the person making the submission. Furthermore, the textual description may be heavily edited (in some instances almost beyond recognition)—or even deleted—depending on the exaction of the editor. Because of this editorial process, posting of the listing is not immediate. Furthermore, once the listing has been posted to the database, if the person making the listing later wishes to change the listing in some respect, the change must again pass through the same laborious channel. Hence, the process of adding and updating listings is inconvenient and unsatisfactory.

Moreover, the nature of the listing is rather prosaic. The listing is in title/brief-description format and does not include graphical elements or otherwise appeal to the artistic sensibilities of the viewer. In this sense, the listing is comparable to the standard telephone book listing, which appears in plain text, nothing added, as compared, say, to a quarter-page advertisement with custom artwork and the like.

To use the foregoing service, one is required have a Web homepage. If a user has no Web presence but wishes to establish one, the foregoing service is entirely unavailable. The typical user must first establish a Web presence by paying a Web consultant to produce a homepage and then paying an Internet Service Provider to house that homepage on the Web. This undertaking can prove to be quite costly for an individual or a small business.

What is needed, then, is an information service that overcomes the foregoing disadvantages.

SUMMARY OF THE INVENTION

The present invention, generally speaking, uses a computer network and a database to provide a hardware-independent, dynamic information system in which the information content is entirely user-controlled. Requests are received from individual users of the computer network to electronically publish information, and input is accepted from the individual users. Entries from the users containing the information to be electronically published are automatically collected, classified and stored in the database in searchable and retrievable form. Entries are made freely accessible on the computer network. In response to user requests, the database is searched and entries are retrieved. Entries are served to users in a hardware-independent page description language. The entries are password protected, allowing users to retrieve and update entries by supplying a correct password.

Preferably, the process is entirely automated with any necessary billing being performed by secure, on-line credit card processing. The user making a database entry has complete control of that entry both at the time the entry is made at any time thereafter. The entry, when served to a client, is transformed on-the-fly to the page description language. Where the page description language is HTML and the computer network is the World Wide Web, the entry may function as a "mini" homepage for the user that made the entry. Provision is made for graphics and other kinds of content besides text, taking advantage of the content-rich nature of the Web.

Because the user controls both the content of an entry and the manner in which it is classified, the database functions as a directory to allow the Web public to quickly and precisely find current and accurate data about the user, the user's products and services, etc., without requiring the user to have a conventional Web homepage. The user's mini homepage can be included in many different categories, with the user having the flexibility to change the categories or the descriptive content of the page at any time. Preferably, hyperlink services are also provided, by including within the page links to an E-mail address or to one or more other conventional homepages (or other mini homepages). The E-mail address may be a private E-mail address established on the host machine, avoiding the need to obtain a conventional E-mail address. An inexpensive way is therefore provided to set up a Web site with key information that might otherwise be very costly to widely distribute, and to achieve an Internet presence with a minimum of effort and expense.

BRIEF DESCRIPTION OF THE DRAWINGS

The present invention may be further understood from the following description in conjunction with the appended drawing. In the drawing:

FIGS. 1A and 1B are simplified block diagrams of alternative embodiments of the system of the present invention;

FIG. 2A through FIG. 2T are screen shots showing use of the system and method of the present invention;

FIG. 3 is a flowchart of the operational steps involved in the present system and method;

FIG. 4 is a block diagram showing various ones of the HTML front-ending tools of FIG. 1 and their functional interrelationships; and

FIG. 5 is a simplified block diagram showing the manner in which whois and traceroute services are made readily available through HTML front-ending and augmented with hyperlink services.

DETAILED DESCRIPTION OF THE PREFERRED EMBODIMENTS

Referring to FIG. 1A, there is shown a simplified block diagram of the system of the present invention. A server site **101** is connected to the computer network **103** such as the Web or a Wide Area Network (WAN) other than the Web. At the server site, server software runs on a suitable server platform. In the case of the Web, for example, the server of FIG. 1A might be a server available from the National Center for Supercomputing Applications (NCSA), or a secure server package of a known, commercially-available type, running on a super-minicomputer such as a SunServer machine available from Sun Microsystems of Menlo Park, Calif., or on any of a wide variety of suitable UNIX platforms. Also running, either on the same machine or a network-accessible machine, is a database management system **107**. Preferably, the database management system **107** supports Standard Query Language, or SQL. One suitable database management system is MiniSQL, which is also commercially available.

SQL databases, however, are not inherently "Web-friendly." Accordingly, a variety of HTML front-ending tools **109** are provided which run as extensions to the server software, allowing computer network users to each add entries to a database, search entries in the database, and update entries by that particular user, all using the Web (or a Web-like) graphical user interface. The server software and the HTML front-ending tools communicate through the Common Gateway Interface **111**. In accordance with another embodiment, shown in FIG. 1B, the HTML front-ending tools may be fully integrated with the server software. The HTML front-ending tools and the database communicate through SQL (**113**).

When a network user visits the server site, the user is served a main page in a page description language such as HTML. The user interacts with the page, making selections or requests. These selections or requests, although they may not appear as such to the user, are in effect page requests, e.g., URLs that access a page directly or that call a CGI script to perform some sort of processing. The result of the selection or request may be a page eliciting a further selection or request, or may be contain the desired information itself.

In order to convey the manner in which the automated information service and directory is used, screen displays of the graphical user interface will now be described.

When a user first visits the site, he or she is presented with a main page as shown in FIG. 2A. Along the side of the page are icons that may be clicked on to select different services. An icon **201** selects a "WebBook" service in which database entries may be searched, viewed and updated. An icon **203** selects a "WebWho Whois" service, providing a graphical front end to the United States Whois database, with additional hypertext link integration. An icon **205** selects the "WebWho Traceroute" service, providing a graphical front end to the Traceroute utility, again with additional hypertext link integration. An icon **207** in the top left shows the current page's icon and is not linked.

When the icon **201** is selected, the user is presented with a page like that shown in FIGS. 2B, 2C, and 2D. At the top of the page appears a table **209** presenting examples of valid

5

entry types for Whois, i.e., Domain Name, Machine Name, Registered Handle, Registered Name, IP Address and IP Network. Next appears a text input field 211 to receive the information to be looked up. Next appears an example of the results of a specific lookup. The user has input his or her request, and results have been received back and displayed in a results area 213. As described more fully below, links are embedded in the results such that, by clicking on an area 215 displaying ccoley@SRMC.COM, for example, an E-mail utility will be invoked showing a blank E-mail addressed to ccoley@SRMC.COM. Similarly, domain names, IP addresses, etc. may be clicked on, with the result that Whois is queried once again with respect to the selected information.

At the bottom of the page appears a Navigational Aid 217 used throughout the user interface where appropriate to allow the user to return directly to a particular entry point in the program flow without having to follow numerous links as is typical of the prior art.

When the icon 203 is selected, the user is presented with a page for the Traceroute utility like that shown in FIGS. 2E and 2F. The various features of the page will be evident from the preceding description. One feature, however, bears particular mention. That is, just as clicking a domain name or the like in Whois produces a further query, bringing up additional information, similarly, clicking on names or addresses in FIG. 2C also produces a further query, not of Traceroute but of Whois. For example, if one wanted to find additional information about the machine on line number of 1 of FIG. 2C, one could simply click on the IP address 205.138.192.1 displayed in the area 219. This action would produce the same result as if the user had copied down the IP address, navigated to Whois and entered the IP address in the lookup field.

When the icon 205 is selected, the user is presented with a page like that shown in FIG. 2G. The navigation aid previously described, although not shown in FIG. 2G, may also be included if desired. The user is given the options of searching the database, adding a new entry, updating an existing entry, changing the user's password, or logging in. As described below, login is typically not required to view a listing of entries satisfying a particular search request, although login may be required to view an actual entry itself and is required to update an entry.

When the Search option is selected, the user is presented with a page like that shown in FIG. 2H. Within WebBook, a different type of navigational aid 221 is included that allows the user to quickly move about within WebBook, between Search, Add and Update, or to go to the main page of FIG. 2A. The screen of FIG. 2H allows the user to select between different searching methods, including searching by Categories (going through a categories list), by Example (querying each field of the entries), and by Keyword (specifying a keyword).

When Categories is selected, the user is presented with a page like that shown in FIG. 2I. In the example shown, three root-level categories are presented, BUSINESS, RECREATION, and WEBWHO95. The user selects one of these categories to show further subcategories, as seen in FIG. 2J, which is displayed in response to the user selecting WEBWHO95. A single subcategory is shown—INDEX, having 9250 entries. The entries are listed by title within the lower part of the page. The user may select how many entries are to be displayed at a time in order to quicken response time. Also, presorts are used in order to quickly display the results of a category or keyword search.

6

When Example is selected, the user is presented with a page like that shown in FIG. 2K. The user enters the information to be searched in any field or combination of fields to be searched.

To add a new entry to the database, the user is presented with a page like that shown in FIG. 2L. Each information item in the upper portion of the form is required, unless otherwise indicated. If a required item is not provided, the program will redisplay the form and request the user to complete all required items. Optional items include middle name, alternate phone number, fax number, URL#1, and URL#2.

The remainder of the form is used to enter up to twenty keywords and a description of the user's entry, to be displayed with the entry.

Following entry of keywords and a description of the entry, the user is requested to choose a category for the entry by presenting the user with a page like that shown in FIG. 2M. The user can navigate the category tree until he or she has located the desired category and then select that category. If none of the categories is adequate, then the user may define his or her own category, by entering the name of the category and a short description of the category. The new category will then be added to the category tree.

A sample mini homepage is shown in FIG. 2N and 2O. The mini homepage may be located by searching the database and then selecting the corresponding entry, or may be retrieved directly by URL. The URL of the mini homepage itself should not be confused with URL#1 and URL#2 listed on the mini homepage. The latter refer to independent resources. The URL of the mini homepage itself is, for example, based on a unique transaction ID assigned to each entry and may be entered into a browser program to view the mini homepage directly without searching.

When Update is selected (FIG. 2G), the user, having entered the correct transaction ID and password, is presented with a page like that shown in FIG. 2P. The corresponding mini homepage is displayed, and the user is requested to update the mini homepage (the "post"). When the user has edited the entry to his or her satisfaction, the user presses UPDATE. The user is then presented with a further page like that shown in FIGS. 2Q and 2R, giving him or her the opportunity to review one final time the comments and keywords. To change the comments or keywords, the user presses BACK. The user can also change the category of the entry by pressing the Change category button. To accept and complete the update, the user presses a Done update button.

A page like that shown in FIG. 2S is then presented. The user is required to enter the identification number of the post. If the identification number is entered correctly, the post is updated, and a page like that shown in FIG. 2T is presented to the user, confirming the update.

Referring now to FIG. 3, the operational steps involved in the present system and method are represented. The system is accessed either directly by the user or by following a link to the server site, for example the URL WebWho.com. The name WebWho.™ is a trademark of the present assignee.

The user is first presented with a page 301 (index.shtml) allowing the user to select from different services, including whois and traceroute. As described previously, whois is an Internet service that looks up information about a user in a database. Traceroute is a program that permits a user to find the path a packet will take as it crosses the Internet to a specific destination. Whois and traceroute are known services. Previously, however, use of these services has typically required "root-user access" on a UNIX host. In accordance with one aspect of the present invention, these

services are HTML front-ended and made available to all users, together with further hyperlink services that greatly increase the utility of the underlying whois and traceroute services.

Referring to FIG. 5, whois and traceroute are made readily available to all network users through HTML front-
 ending using CGI scripts. The actual whois code 501 and traceroute code 503 remains within the root directory 500 on a UNIX host. Respective CGI scripts are provided, namely whois.cgi (505) and traceroute.cgi (507), that have root user privileges and that provide HTML front-ending between the user and their respective services. For example, when a user selects the WebWho Whois service from the main page of FIG. 2A, the whois.cgi script 505 is invoked to pass the user input to the root directory whois service 501 and cause it to service the user's request. Output from the root directory whois service 501 is passed back from the whois.cgi script 505 in HTML format. The same description applies equally to the traceroute.cgi script and the root directory traceroute service.

To further augment the whois and traceroute services, hyperlink services are provided. The root directory whois and traceroute services are provided with a parsing routine 509 that parses the output of these services to identify E-mail addresses, domain names, IP names, etc.—character strings containing period separators and/or the character “@.” The parser then passes back this information to the CGI scripts in the form of links, links to the whois.cgi script 505 in the case of names and links to an E-mail.cgi script 511 in the case of E-mail addresses. The E-mail.cgi script 511 controls an E-mail utility 513 that may be located in the root directory or in a different directory.

Whois and traceroute, as implemented as part of the present invention, provide powerful new tools for serious Internet tools. Using whois, the user may type in any address with a “.com”, “.edu” or “.net” extension and find the physical address, phone number and the individual(s) that the address represents. This ability may be used as a powerful marketing tool to find a wealth of information about people on the Internet. Also, whois can be used to instantly check a domain name.

Traceroute may be used by System Administrators to obtain information to make their jobs much easier. Previously, System Administrators have not been allowed to use traceroute on a PC running any operating system other than UNIX.

Whereas whois and traceroute are more technically oriented, “WebBook” allows non-technical users to take advantage of the capabilities of the Web with a minimum of effort. WebBook allows a user to have HTML-front-ended access to a database of mini homepages in order to search, add entries to, or update previous entries in the database.

Referring again to FIG. 3, if WebBook is chosen, a login routine 303 may request the to enter identifying information of the type that would normally be found on a business card, for example. Presently, although Web sites are able to track the user's access point to the Web (for example, a particular slip connection through an Internet Service Provider), this information often gives no indication who the user really is. Such information is important in order to evaluate the extent to which a target audience is being reached.

The user may choose an option that allows the user to bypass the login request. The request for information as to the identity of the user therefore may or may not be complied with; moreover, the information provided may or may not be accurate. As an incentive to provide the requested information (and, it is hoped, the correct infor-

mation), users providing the requested information may be given more complete access to the database than users who do not provide the requested information. Users providing the requested information are assigned a user ID to be used during subsequent accesses and are requested to choose a password. The password may be required to access some system services. To further encourage voluntary login, users that have complied with the login request and have been assigned a user ID may be afforded the ability to customize the user interface and maintain the resulting look and feel between uses. This customization is performed in a known manner by storing on the host a user preferences file and accessing the file to restore user preferences when a valid user ID is provided.

For a period during the initial stages of the service, while the database is still being built up, it may be desirable to allow all users complete access to the database regardless of whether or not they have identified themselves.

Following the login procedure, the user is provided with a page 305 presenting the different ways that the user may interact with the database. For example, a user may search the database, add a new entry to the database, or update a previous entry to the database by that user. Each of these options will be described in turn.

If the user chooses to search the database, the user is provided with a page 307 concerning different search options. A search may be performed on one or more of a number of different database fields, depending on the organization of the database entries. For example, in a preferred embodiment, the database entries include the following defined fields:

uid	country
fname	email
lname	url
mname	keywords
title	comment
ident	category
phone 1	active
phone 2	start.sub.--date
fax	expire.sub.--date
addr	info1 (Reserved)
city	info2 (Reserved)
state	info3 (Reserved)
zipcode	info4 (Reserved)

In one embodiment, searches may be performed by category, by keyword, by URL, or by example. To facilitate rapid retrieval of information, presorted listings may be stored for each category and keyword or for some number of the most common categories and keywords. To search by example, the user is provided with a form having the same organization as the database entries. The user fills in information in the fields of interest. The search then returns information concerning entries having matching information in those fields. Entries are displayed in list fashion by title on a page 309.

The number of entries produced by a search may be very large. Therefore, instead of displaying a listing for all of the entries at once, the entries may be displayed ten at a time, for example. Alternatively, only the first 100 or 200 entries may be displayed.

While some sites may provide information and services free of charge, for example as a result of volunteerism or advertising subsidies, other sites may have a business model in which users are charged for information or services or both. For such a site, it becomes critical to protect the

information stored in the database. Therefore, unlike some existing databases in which actual hypermedia links to Web homepages are stored in the listed items, in order to prevent effectual pirating of the database, links are embedded only in the full entry itself, not in the entry listings. Otherwise a user could simply store a voluminous listing or various different listings, with their accompanying hypermedia links, and thereby capture in large part the entire benefit of the database. Instead, an item in a listing is intended only to give the user enough information to gauge the user's further interest in an item. If the user is interested in an item, the user may select that item, causing the full-page entry to be provided. The full page entry includes links to any E-mail address or URL that the owner of the entry may have provided, thereby providing a link to that person's or organization's homepage (or to some other homepage).

If the user bypassed login, as determined in step 311, he or she will normally be returned to the login procedure when attempting to select an entry to view it in its entirety. If the user has logged in, then the user may select an entry and the corresponding full page 313 will be served to the user.

The full page entry 313 need not be limited to text alone but may be a complete hypermedia page, including possible graphics or other non-textual content. In this manner, for person's or organizations not having any independent Web homepage, the entry can function as a "mini-homepage," i.e., a single page hypermedia document. Furthermore, the mini-homepage may have its own URL, allowing it to be accessed directly without performing a search of the database. For example, a URL for a mini homepage might be <http://webwho.com/view?id=xxxx>, where xxxx represents a transaction ID assigned to each entry in a manner described below.

A link 315 is embedded in the mini-homepage to allow for the page to be updated. Prior to describing the manner in which the mini-homepage is updated, however, the manner of adding a new entry to the database will first be described.

In order to add an entry to the database, a user must login, during which the user chooses a password, or must have logged in during a previous visit to the site. When the user chooses to add a new entry to the database, a unique transaction ID is created for that entry, to be used throughout the life of the entry. A unique transaction ID may be created in any of many different ways. For example, the transaction ID might be the date (e.g., 951215) and the entry number for that date (e.g., 00215). Alternatively, the transaction ID might be the time of day (e.g., HHMMSS) and the process ID of the host machine process that is servicing the user's request. In one embodiment, the transaction ID is a 14-digit hexadecimal number in which eight digits represent the number of seconds since an arbitrary date (e.g., Jan. 1, 1970), four digits represent the process ID running on the host machine, and two digits represent a portion of the machine IP address (to distinguish between different host machines).

Once a transaction ID has been assigned, the user is then provided with an entry form 317 having fields corresponding to the various fields of a database entry as described previously. The user fills out the form and presses a screen button when the entry is complete. The form may have one or more checkboxes 319 to indicate the desire to include with the entry one or more non-textual elements, such as a graphic image, etc. Also, if desired, different templates may be provided governing the appearance of the finished page, with the user selecting a desired template.

Non-textual content may be obtained from the user in any of a number of different ways. For example, the user may

transfer to the site a file containing the non-textual content using the File Transfer Protocol (FTP) with the same user ID and password as when the entry was added.

During the entry process, the user is prompted to enter keywords to facilitate later searching of the database and location of the entry. Furthermore, the HTML front-end tools may assist in developing keywords for the entry. A pre-searchsort tool, for example, might take the 2000 top keywords found in the database within the keyword field and do a total text search throughout the database for these keywords. If one or more of these keywords appears in the description ("comment" field) of an entry but not in the keyword list, these keywords are then added to a keyword extension field for up to some number of keywords, e.g. five.

If the server site is based on a pay-for-service model, the form will also call for the user to enter a credit card number as the last piece of information. Secure, on-line credit card processing will then be performed to bill the user, either on a onetime basis, on a periodic basis, or on an occasional basis as future services may require. Although various methods of processing credit card transaction on-line have been proposed, with various degrees of attendant security, such processing is preferably performed in accordance with a proprietary method developed by the assignee to provide the highest level of security possible.

After an entry has been made, it may be updated at any time by one able to provide the transaction ID assigned to the entry and the user password, i.e., by the user or one acting on behalf of the user. The update option may be entered directly, or the entry to be updated may first be viewed as the result of a search and the update screen button 315 then pressed. The user is then prompted to supply the correct transaction ID and password (page 321), failing which the user will not be allowed to update the entry.

If the transaction ID and password are correctly supplied, then the equivalent of a new entry form will be provided to the user will the current information pertaining to the entry already filled in. The user may then modify the entry. If a charge is made for updating the entry, preferably the credit card information from the earlier creation of the entry will have been stored in a highly secure fashion, avoiding the need to reenter the information. Both security and convenience are thereby enhanced.

Nothing in the process of adding, searching and updating entries requires manual intervention. Rather, the entire process is automated and may be made available continuously, 24 hours a day, 365 days a year. Like a publicly-accessible bulletin board, the content that is posted on the database is entirely within the control of the user, both at the time the entry is posted and all times thereafter.

Referring now to FIG. 4, various ones of the HTML front-ending tools of FIG. 1 and their functional interrelationships will now be described.

When a user visits the site and the WebWho option is selected, a page WebWho.html (401) is served to the user, offering the user various options, including, for example, options to search the database, add a new entry, update an existing entry, change the user's password, or to log in if the user has not previously done so. In an exemplary embodiment, the routines illustrated in FIG. 4 are standard C routines, called from a single CGI script. In other embodiments, the routines may be called by separate scripts, and may be written other languages such as in a UNIX shell language, or in one of a number of emerging Internet computer languages such as Java.

The Options routine 403 reads in the user's choice and invokes one of the five following routines: Search (405),

11

Add (407), Update (409), Changepw (411), and Login (413). Each of these options will be described in turn.

If Search is chosen, the Search routine 405 initiates one of several possible search functions. In a preferred embodiment, these functions include a categories search, an example search, and a keyword search. According to the search function chosen, the Search routine invokes one of the following routines: Categories (415), Example (417), and Key.sub.—Search (419).

Categories are represented in computer memory in the form of a tree structure. A categories search starts from the root level, with the Categories routine 415 displaying all the categories available at that level, and all the entries (or up to some number of entries) belonging to that level. The user can click on any category to go to the next level, and can click on any entry to bring up the mini page of the entry.

If Example is chosen, the Example routine 417 displays a form for the user to fill in any field he or she wants to search on. The Example routine 417 reads in the information and displays all the entries that match what has been specified.

If Keyword is chosen, the Key.sub.—ysearch routine 419 displays text boxes to read in up to a specified number of keywords (e.g., four) to search on. The Key.sub.—search routine 419 displays all the entries that match the specified keywords.

When a user clicks on one of the entries returned by a search function, the mini page is displayed by a List.sub.—entries routine 421. List.sub.—entries displays the mini page for a particular entry and also contains an update button for the user to update that particular entry.

When a user specifies that he or she wants to edit the entry currently being displayed, the Update routine 409 performs a check to see if that page belongs to the user currently logged in. If so, updating is initiated by invoking an Update post routine 423. Otherwise, an Update.sub.—login routine 425 is called to allow the user to perform the correct login sequence. The Update.sub.—login routine 425 reads in a user ID and password and matches them against the database to determine if the user is the owner of the mini page currently being displayed. Updating is not allowed until the correct user ID and password are entered.

The Update-post routine 423 displays an entry form with values filled in from the information stored in the database. It invokes a Do.sub.—update routine 427 to process the new values being entered. The Do.sub.—update routine reads in the new information, makes sure that all the required information is filled. If not, a routine Do.sub.—missing is invoked. When all of the required information has been supplied, a Update.sub.—key routine 429 reads in the keywords and comments from the database entry, displays them, and asks the user to confirm. The user can go ahead and update the database or can change the category the entry currently belongs to.

If the user chooses to change the category, a Change.sub.—cat routine 431 displays all the categories at the root level. The user can click on one of the categories to go to the next level or can specify a new category on the current level. If the user chooses to go ahead and update the database, another form is displayed to read in the identification number of the entry. A Get.sub.—ident routine 435 is then invoked. If the user chooses to change the category, an Update.sub.—cat routine 433 handles navigation through the categories tree. It will keep displaying the categories on the current level until the user has decided on a category or has specified a new category.

12

The routine Get.sub.—ident 435 reads in the identification number and matches it against the identification number stored in the database for the current entry. If they match, the database is updated; otherwise, the program declines the update.

Entries may also be updated directly without searching, using the Update routine 409. If a user is currently logged in, the Update routine 409 displays all the entries belonging to that user. Otherwise, the Update.sub.—login routine 425 performs a login and displays all the entries belonging to the newly logged-in user. The remaining update routines have already been described as a continuation of the search options and will therefore not be further described.

When Add is selected, the Add routine 407 displays an empty form to allow the user to fill in all the information. The Add routine 407 processes the information that has been entered, using the Do.sub.—missing routine to make sure that all the required information is entered. The Do.sub.—missing routine displays the form again until all the required information is entered.

After all the required information has been entered, a Get.sub.—info routine 437 displays another form to read in the keywords and comments. A Confirm.sub.—info routine 439 processes the keywords and comment being entered and displays them again, asking the user to confirm. After the user confirms the keywords and comments, a Pick.sub.—cat routine 441 acquires the category using the same mechanism previously described in relation to Update.sub.—cat. If the user is not logged in, he or she is logged in, and a new user ID is determined. A form is then displayed to read in the user's password. A Get.sub.—pw routine 443 reads in the password and displays a form to read in credit card information. A Get.sub.—cc routine 445 verifies the credit card information. If the transaction is authorized, it adds the new entry into the database; otherwise, it rejects the entry.

The remaining routines are administrative in nature. The user may wish to change his or her password. If the user is not currently logged in, a login is performed by calling a Changepw.sub.—login routine 447. Changepw.sub.—login reads in the user ID and password and matches them against the values in the database. A form is then displayed to read in the new password. The Changepw routine 411 actually updates the database with the new password.

The Login routine 413 reads in the user ID and password and checks them against the database. If the user ID and password are correct, operation begins at the main page with the user logged in as the new user.

It will be appreciated by those of ordinary skill in the art that the invention can be embodied in other specific forms without departing from the spirit or essential character thereof. The foregoing description is therefore considered in all respects to be illustrative and not restrictive. The scope of the invention is indicated by the appended claims, and all changes which come within the meaning and range of equivalents thereof are intended to be embraced therein.

The invention claimed is:

1. A web server for providing a dynamically-updating pay-for-service web site comprising:

a web server coupled to a computer network having a database operatively disposed within and accessible on said network, said server comprising:

an HTML front-end entry process configured to:

create and store personal homepage content in a database for a owner;

receive a fee from said owner for making said personal homepage accessible on said network; and

13

an HTML front-end update process configured to allow said owner to update said personal homepage over said network.

2. The apparatus of claim 1, wherein said content includes categories of information.

3. The apparatus of claim 2, further including non-textual information associated with said categories.

4. The apparatus of claim 3, wherein said non-textual information includes graphics.

5. The apparatus of claim 1, wherein said content includes keywords.

6. The apparatus of claim 5, wherein said content includes categories associated to said keywords.

7. The apparatus of claim 6, wherein said content includes categories associated to said second set of keywords.

8. The apparatus of claim 7, wherein said content categories associated to said keywords and further associated to an additional set of categories.

9. The apparatus of claim 1, wherein said account further includes personalized information.

10. The apparatus of claim 9, wherein said personalized information includes a URL to the user's homepage.

11. The apparatus of claim 10, further including the act of password-protecting said account.

12. A method for providing a dynamically-updating pay-for-service web site comprising:
providing a web server coupled to a computer network having a database operatively disposed within and accessible on said network;

14

using an HTML front-end entry process;
creating and storing personal homepage content in a database for a owner;

receiving a fee from said owner for making said personal homepage accessible on said network; and
allowing said owner to update said personal homepage over said network.

13. The method of claim 12, wherein said content includes categories of information.

14. The method of claim 13, further including non-textual information associated with said categories.

15. The method of claim 14, wherein said non-textual information includes graphics.

16. The method of claim 12, wherein said content includes keywords.

17. The method of claim 15, wherein said content includes categories associated to said keywords.

18. The method of claim 16, wherein said content includes categories associated to said second set of keywords.

19. The method of claim 18, wherein said content categories associated to said keywords and further associated to an additional set of categories.

20. The method of claim 12, wherein said account further includes personalized information.

21. The method of claim 20, where said personalized information includes a URL to the user's homepage.

22. The method of claim 12, further including the act of password-protecting said account.

* * * * *